

1970 Sidewinder PARTS DIAGRAM

KICKSTARTER MECHANISM

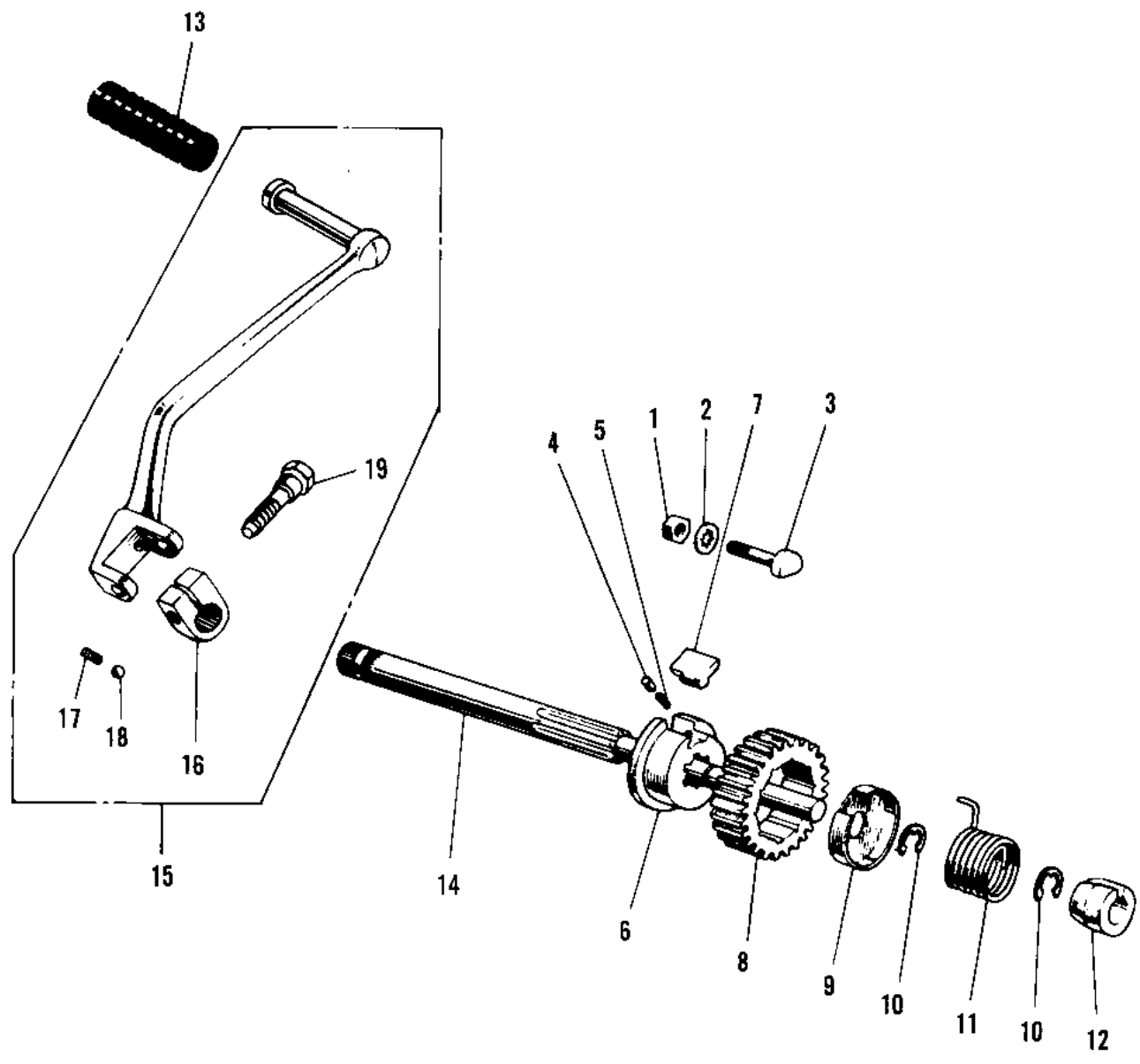

1970 Sidewinder PARTS LIST

KICKSTARTER MECHANISM

ITEM NAME	PART NUMBER	QUANTITY
NUT 8MM (Ref # 1)	312B0800	
WASHER LOCK 8MM (Ref # 2)	463H0800	
WASHER LOCK 8MM (Ref # 2)	463H0800	
STOPPER KICKSTARTER (Ref # 3)	13072-004	
PIN KICKSTARTER PAWL (Ref # 4)	92042-001	
SPRING CLUTCH (Ref # 5)	92081-001	
SPRING KICK PAWL (Ref # 5)	92081-022	
DRUM KICKSTARTER (Ref # 6)	13067-003	
PAWL KICKSTARTER (Ref # 7)	13069-003	
GEAR KICKSTARTER (Ref # 8)	13068-014	
PLATE KICK GEAR HLDER (Ref # 9)	13071-003	
CIRCLIP 10MM (Ref # 10)	482J0100	
SPRING KICKSTARTER (Ref # 11)	92082-002	
GUIDE KICK SPRING (Ref # 12)	13070-001	
RUBBER KICK PEDAL (Ref # 13)	13063-004	
SHAFT KICKSTARTER (Ref # 14)	13066-009	
SHAFT KICKSTARTER (Ref # 14)	13066-014	
PEDAL,KICKSTARTER (Ref # 15)	13064-016	
PEDAL,KICKSTARTER (Ref # 15)	13064-016	
UNAVAILABLE IN PRICE BOOK (Ref # 16)	13061-002	
BOSS KICK PEDAL (Ref # 16)	13061-007	
SPRING KICK PEDAL (Ref # 17)	92081-020	
BALL STEEL 1/4' (Ref # 18)	600A0800	
BOLT 10MM (Ref # 19)	92001-071	
BOLT 10MM (Ref # 19)	92001-071	