

# 1986 KE100 PARTS DIAGRAM

CLUTCH

E1350-0007

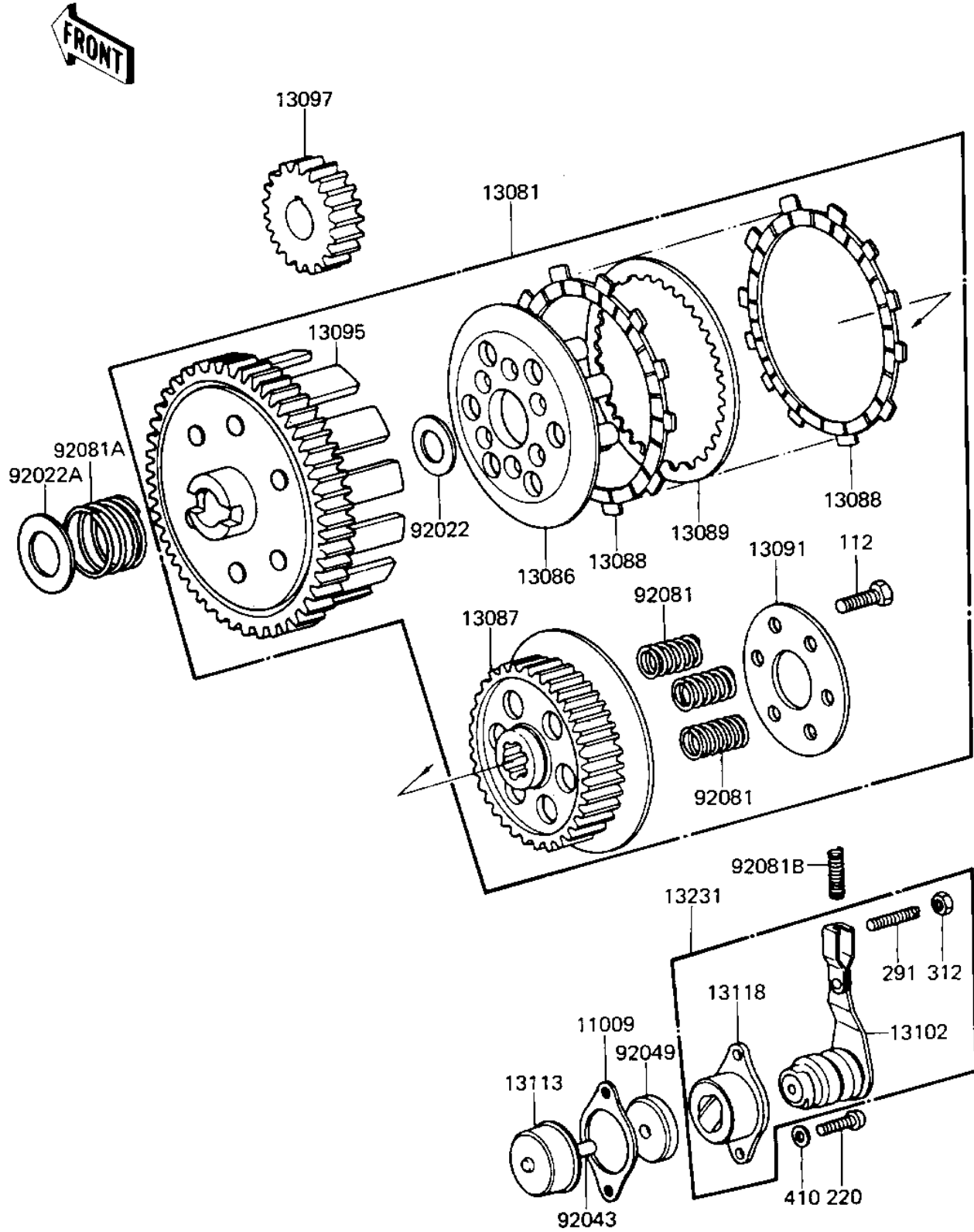

# 1986 KE100 PARTS LIST

## CLUTCH

| ITEM NAME                            | PART NUMBER | QUANTITY |
|--------------------------------------|-------------|----------|
| GASKET,CLUTCH RELEASE (Ref # 11009)  | 11060-1197  | 1        |
| CLUTCH-ASSY (Ref # 13081)            | 13081-028   | 1        |
| WHEEL,CLUTCH (Ref # 13086)           | 13086-1002  | 1        |
| HUB,CLUTCH (Ref # 13087)             | 13087-1011  | 1        |
| PLATE-FRICTION (Ref # 13088)         | 13088-1103  | 4        |
| PLATE-CLUTCH,STEEL (Ref # 13089)     | 13089-1009  | 3        |
| HOLDER,CLUTCH SPRING (Ref # 13091)   | 13091-1115  | 1        |
| HOUSING CLUTCH (Ref # 13095)         | 13095-022   | 1        |
| PINION,PRIMARY (Ref # 13097)         | 13121-032   | 1        |
| RELEASE-COMP-CLUTCH,I (Ref # 13102)  | 13102-1016  | 1        |
| PUSHER CLUTCH SPRING (Ref # 13113)   | 13113-003   | 1        |
| RELEASE-CLUTCH OUTER (Ref # 13118)   | 13118-1001  | 1        |
| RELEASE-ASSY-CLUTCH (Ref # 13231)    | 13231-1008  | 1        |
| WASHER THRUST CLUTCH (Ref # 92022)   | 92022-054   | 1        |
| WASHER PLAIN (Ref # 92022A)          | 92022-057   | 1        |
| PIN,DOWEL (Ref # 92043)              | 92042-043   | 1        |
| OIL SEAL (Ref # 92049)               | 92050-071   | 1        |
| SPRING CLUTCH (Ref # 92081)          | 92081-012   | 6        |
| SPRING CLUTCH DAMPER (Ref # 92081A)  | 92081-015   | 1        |
| SPRING-CLUTCH RELEASE (Ref # 92081B) | 92081-096   | 1        |
| BOLT-UPSET (Ref # 112)               | 112G0516    | 6        |
| SCREW PAN HEAD 6X16 (Ref # 220)      | 220B0616    | 2        |
| SCREW,SLOTTED,6X16 (Ref # 291)       | 291H0616    | 1        |
| NUT 6MM (Ref # 312)                  | 312B0600    | 1        |
| WASHER PLAIN 6MM (Ref # 410)         | 410B0600    | 2        |