

1986 KE100 PARTS DIAGRAM

SWING ARM/SHOCK ABSORBERS

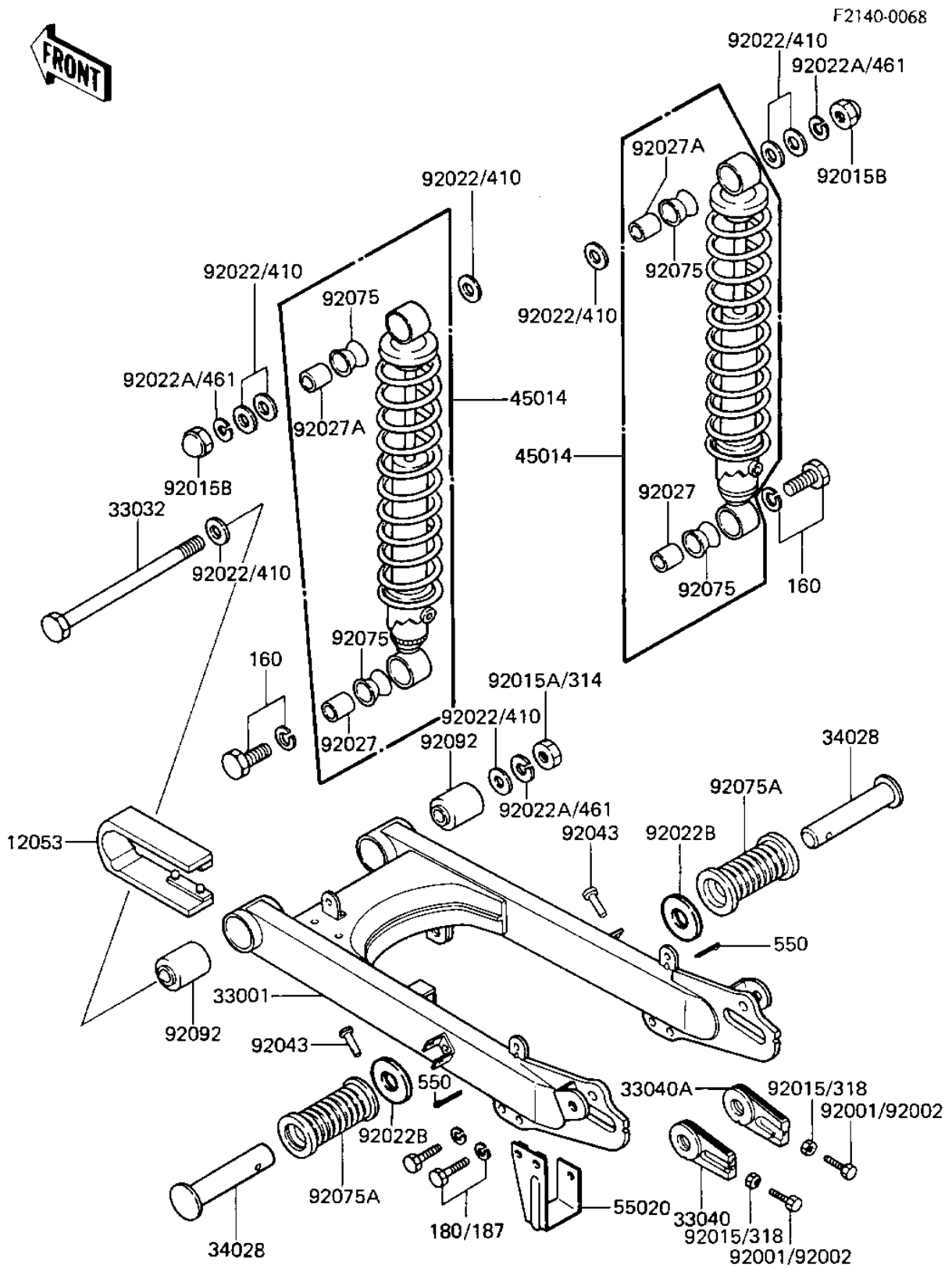

1986 KE100 PARTS LIST

SWING ARM/SHOCK ABSORBERS

ITEM NAME	PART NUMBER	QUANTITY
GUIDE-CHAIN,NYLON (Ref # 12053)	12053-1066	1
ARM-COMP-SWING,SILVER (Ref # 33001)	33001-1118	1
SHAFT-SWING ARM PIVOT (Ref # 33032)	33032-034	1
ADJUSTER-CHAIN,L.H. (Ref # 33040)	33040-045	1
ADJUSTER-CHAIN,R.H. (Ref # 33040A)	33040-046	1
BAR-RR FOOTREST (OPT) (Ref # 34028)	34028-009	2
SHOCK ABSBR RR (Ref # 45014)	45014-1144	2
GUARD,CHAIN (Ref # 55020)	55020-012	1
BOLT,8X50 (Ref # 92002)	92002-1076	2
NUT,8MM (Ref # 92015)	92015-1364	2
NUT,12MM (Ref # 92015A)	92015-1381	1
NUT 12MM (Ref # 92015B)	92020-014	2
WASHER,12MM (Ref # 92022)	92022-1538	8
WASHER SPRING 12MM (Ref # 92022A)	461F1200	3
WASHER,20X30X2.3 (Ref # 92022B)	92022-1568	2
BUSH SHCK ABS PVT SFT (Ref # 92027)	45016-003	2
BUSHING,SHOCKABSORBER (Ref # 92027A)	92027-1063	2
PIN (Ref # 92043)	92043-1464	2
BUSHING,RUBBER (Ref # 92075)	92075-1020	4
RUBBER,REAR FOOTREST (Ref # 92075A)	92076-024	2
RUBBER,REAR FOOTREST (Ref # 92092)	92076-024	2
BOLT-FINE-WS (Ref # 160)	160N1035	2
BOLT-UPSET-WSP (Canada) (Ref # 187)	187X0616	2
PIN COTTER 2.0X15 (Ref # 550)	550D2015	2