

1983 Spectre PARTS DIAGRAM

SWING ARM/SHOCK ABSORBERS

F2140-0090

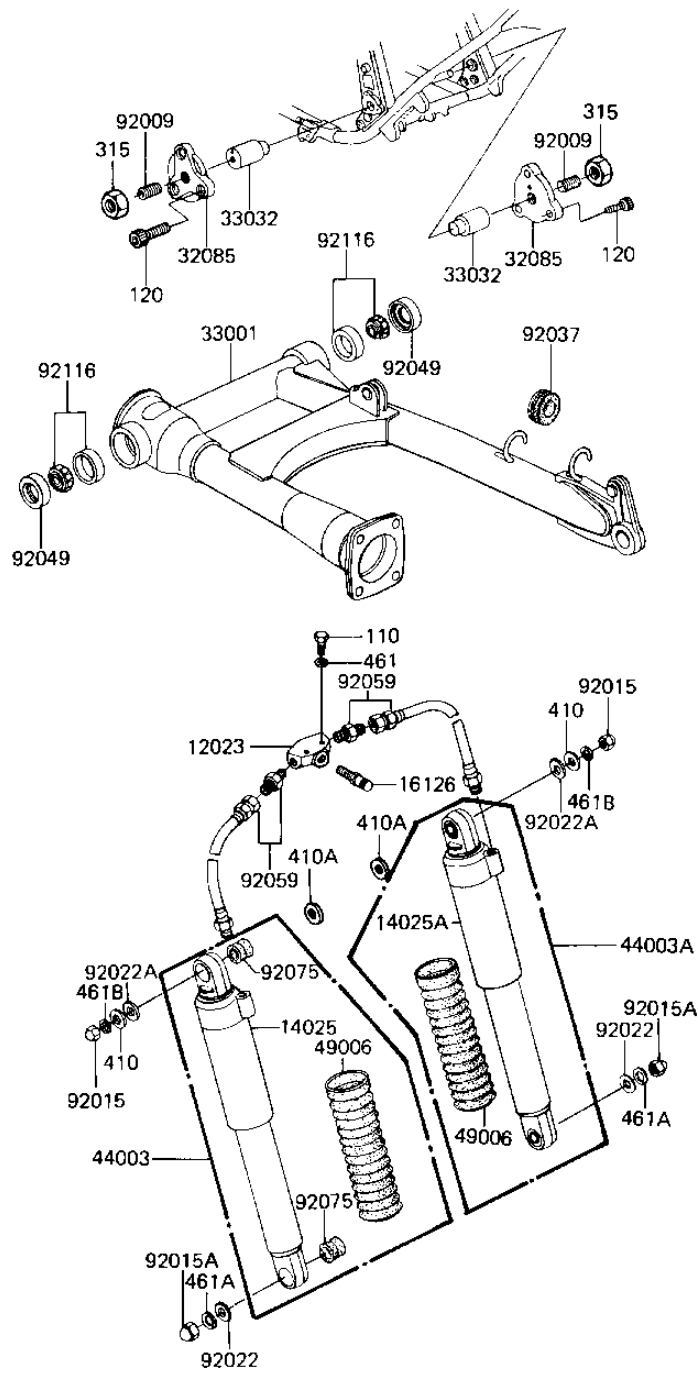

1983 Spectre PARTS LIST

SWING ARM/SHOCK ABSORBERS

ITEM NAME	PART NUMBER	QUANTITY
HOLDER-VALVE,AIR (Ref # 12023)	12023-1012	1
COVER,SHOCKABSORBER,L (Ref # 14025)	14025-1488	1
COVER,SHOCKABSORBER,R (Ref # 14025A)	14025-1489	1
VALVE AIR (Ref # 16126)	16126-1052	1
STOPPER,SWING ARM (Ref # 32085)	32085-1071	2
ARM-COMP-SWING (Ref # 33001)	33001-1102	1
SHAFT-SWING ARM (Ref # 33032)	33032-1021	2
DAMPER-ASSY,RR,LH,GOL (Ref # 44003)	44003-1239	1
DAMPER-ASSY,RR,RH,GOL (Ref # 44003A)	44003-1240	1
BOOT,RR SHOCKABSORBER (Ref # 49006)	49006-1077	2
SCREW,14X22 (Ref # 92009)	92009-1087	2
NUT,LOCK,CAP,12MM,BLA (Ref # 92015)	92015-1192	2
NUT,CAP,10MM,BLACK (Ref # 92015A)	92015-1203	2
WASHER,10.5X30X2.3,BL (Ref # 92022)	92022-1302	2
WASHER,12.4X28X2.3,BL (Ref # 92022A)	92022-1303	2
DAMPER RUBBER (Ref # 92037)	43064-007	2
OIL SEAL,26406 (Ref # 92049)	92049-1030	2
TUBE,SHOCKABSORBER,RR (Ref # 92059)	92059-1194	2
BUSHING,SHOCK ABSORBE (Ref # 92075)	92075-1141	4
BRG,ROLLER,4T30203E1 (Ref # 92116)	92116-1001	2
BOLT-UPSET 6X14 (Ref # 110)	112B0614	2
BOLT-SOCKET,8X20 (Ref # 120)	120S0820	6
NUT 14MM (Ref # 315)	315B1400	2
WASHER-PLANE-SMALL (Ref # 410)	410F1200	2
WASHER-PLANE-SMALL (Ref # 410A)	410F1400	2
WASHER SPRING 6MM (Ref # 461)	461F0600	2
WASHER-SPRING,10MM (Ref # 461A)	461K1000	2
WASHER-SPRING,12MM,BL (Ref # 461B)	461K1200	2