

2013 VULCAN® 1700 VOYAGER® PARTS DIAGRAM

Crankcase Bolt Pattern

E1412

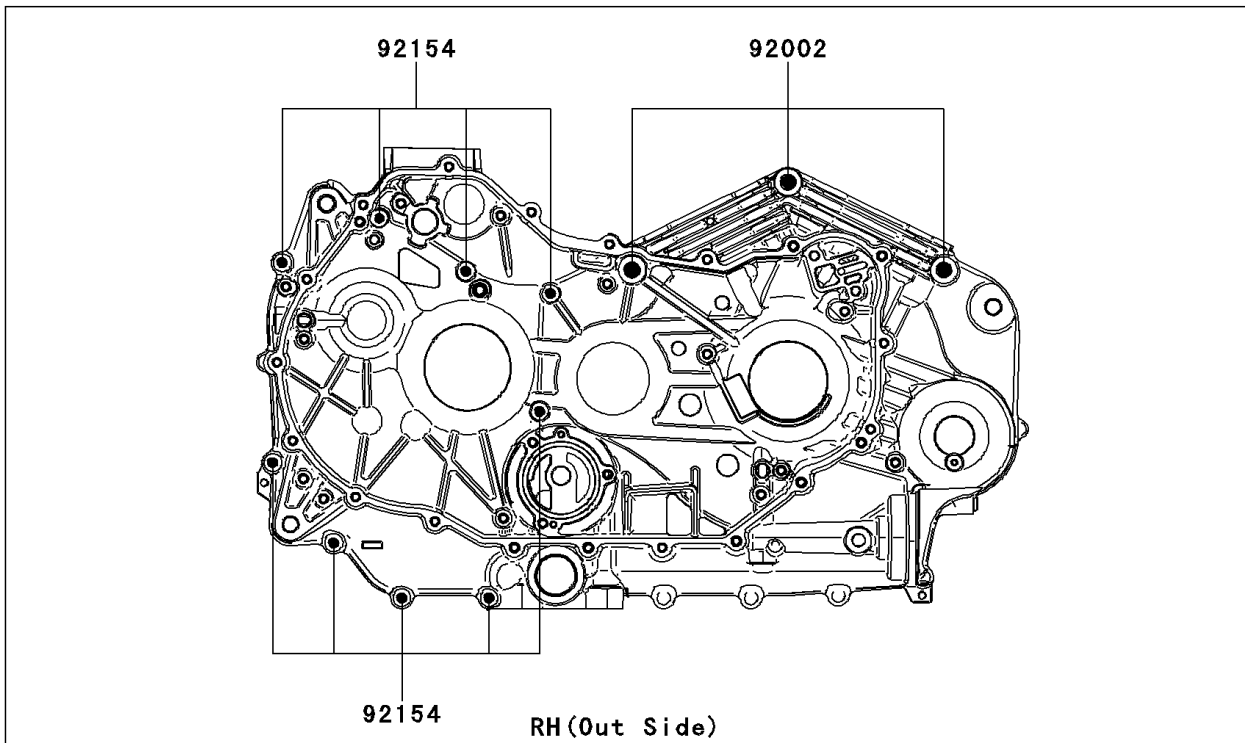
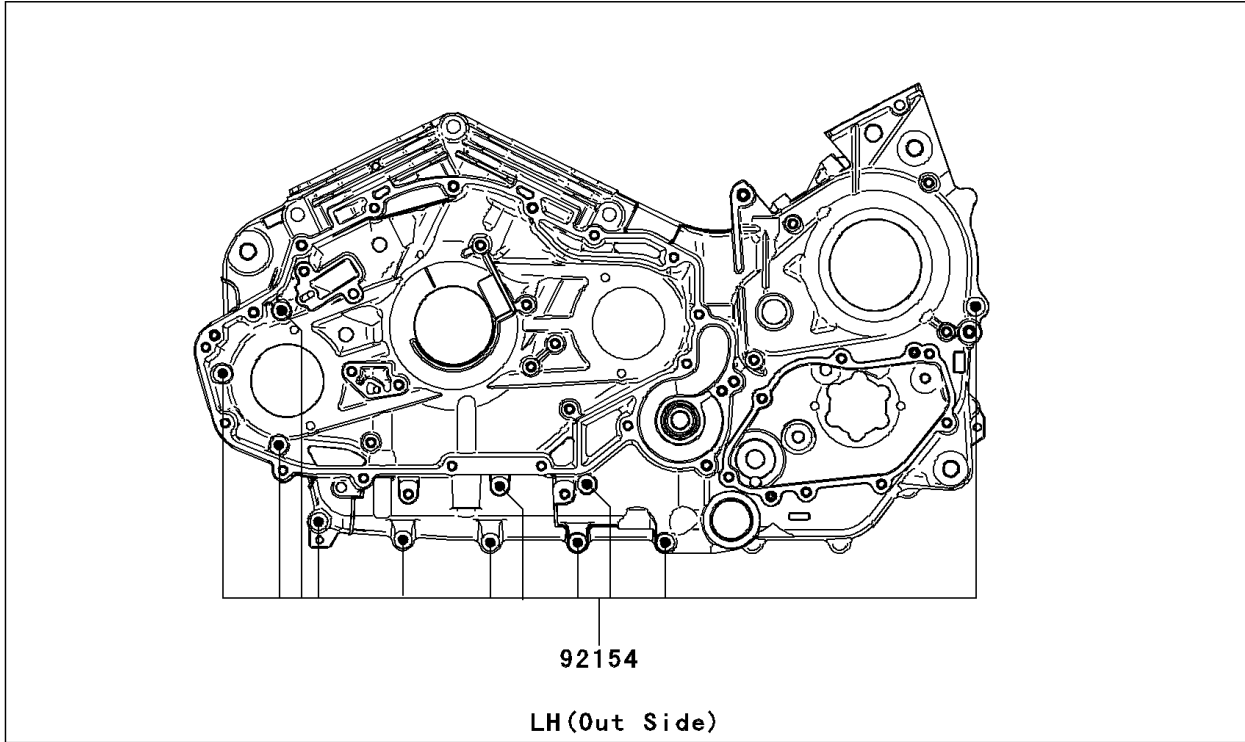

2013 VULCAN® 1700 VOYAGER® PARTS LIST

Crankcase Bolt Pattern

ITEM NAME	PART NUMBER	QUANTITY
BOLT,FLANGED,10X190 (Ref # 92002)	92002-1548	3
BOLT,FLANGED-SMALL,6X90 (Ref # 92154)	92154-0132	20