

1999 KLR650 PARTS DIAGRAM

Crankshaft(KL650AE032206-)

E1321A

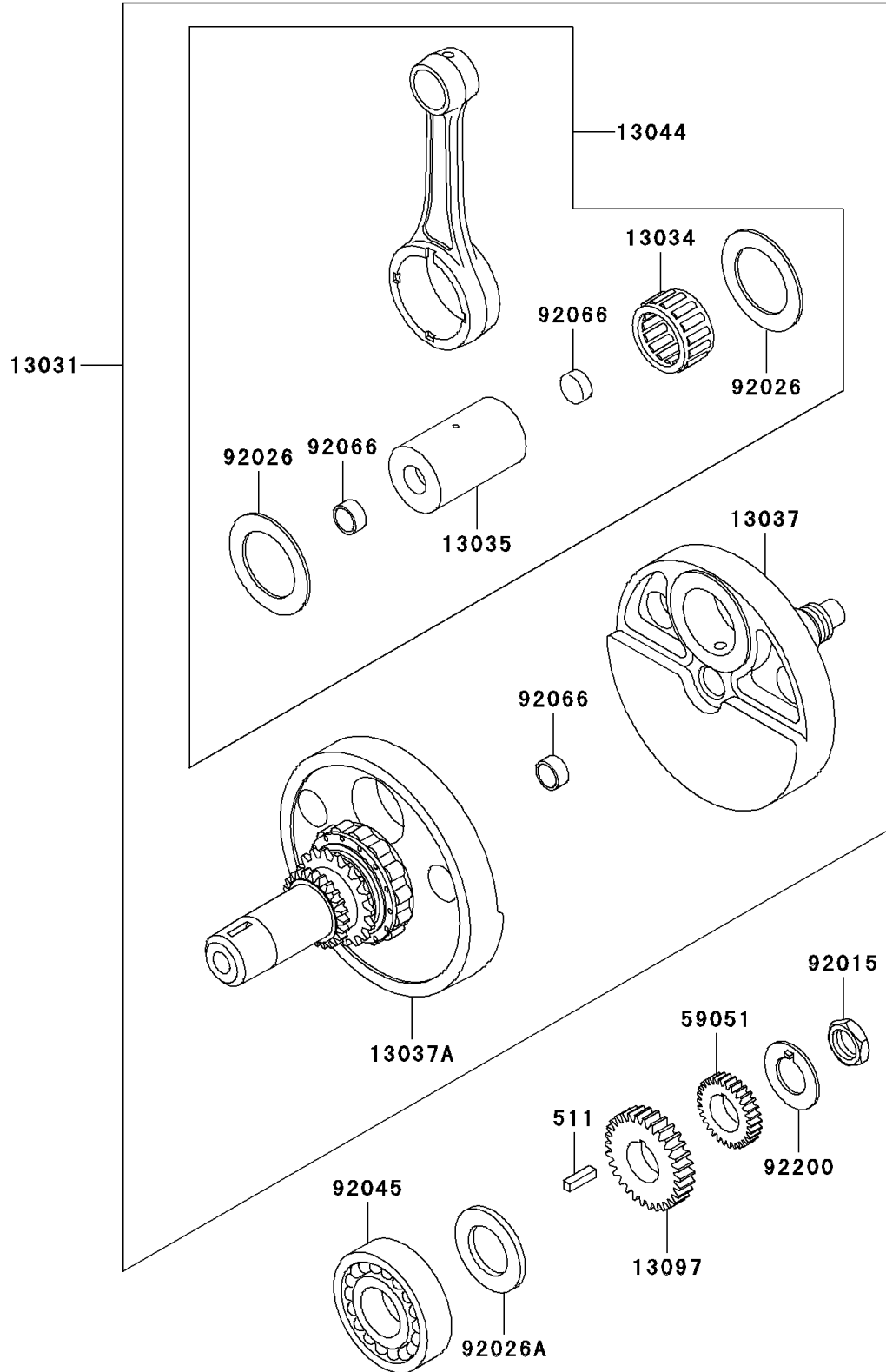

1999 KLR650 PARTS LIST

Crankshaft(KL650AE032206-)

ITEM NAME	PART NUMBER	QUANTITY
KEY-SUNK (Ref # 511)	511A0520	1
CRANKSHAFT-COMP (Ref # 13031)	13031-1396	1
BEARING-BIG END (Ref # 13034)	13034-1084	1
PIN-CRANK (Ref # 13035)	13035-1066	1
CRANKSHAFT,RH (Ref # 13037)	13037-1516	1
CRANKSHAFT,LH (Ref # 13037A)	13037-5088	1
SET-CONNECTING ROD (Ref # 13044)	13044-5073	1
GEAR-PRIMARY SPUR,33T (Ref # 13097)	13097-1333	1
GEAR-SPUR,27T (Ref # 59051)	59051-1145	1
NUT,22MM (Ref # 92015)	92015-1890	1
SPACER,40X60X1.5 (Ref # 92026)	92026-1279	2
SPACER,30X50X4 (Ref # 92026A)	92026-1280	1
BEARING-BALL,TM-SX08A50C3 (Ref # 92045)	92045-1187	1
PLUG (Ref # 92066)	92066-1154	3
WASHER,CLAW (Ref # 92200)	92200-1157	1