

1998 KLR650 PARTS DIAGRAM

Frame

F2120

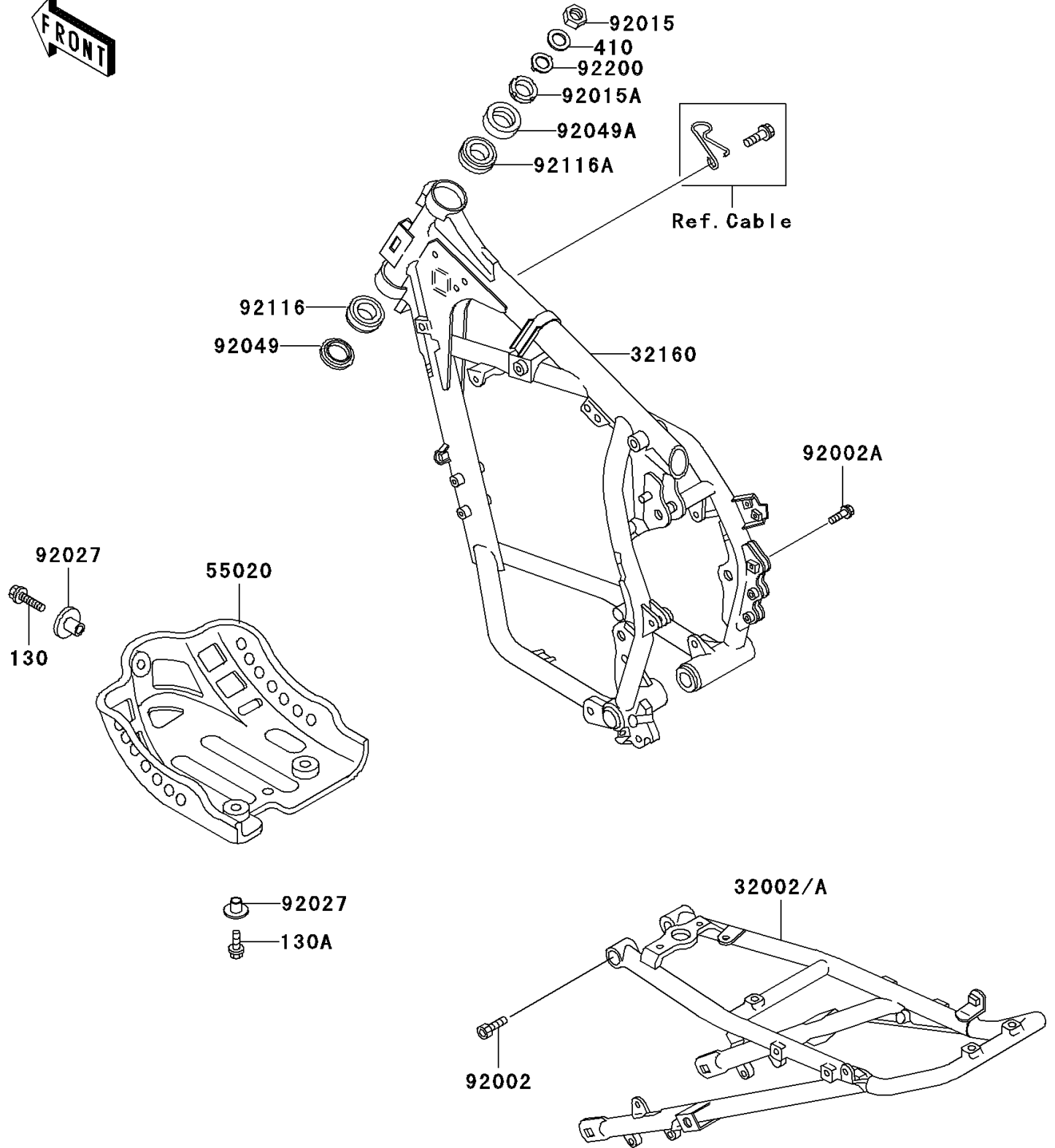

1998 KLR650 PARTS LIST

Frame

ITEM NAME	PART NUMBER	QUANTITY
BOLT-FLANGED,6X12 (Ref # 130)	130G0612	1
BOLT-FLANGED,6X14 (Ref # 130A)	130G0614	2
W-PLAIN-S (Ref # 410)	410F1800	1
FRAME-COMP,FR,SILVER NO.25 (Ref # 32160)	32160-1408-CE	1
GUARD,ENGINE,BLACK (Ref # 55020)	55020-1249-6Z	1
BOLT,SOCKET,8X30 (Ref # 92002)	92002-1844	2
BOLT,FLANGED,8X28 (Ref # 92002A)	92002-1971	2
NUT,18MM (Ref # 92015)	92015-1404	1
NUT,25MM,T=12 (Ref # 92015A)	92015-1546	1
COLLAR (Ref # 92027)	92027-1794	3
SEAL-OIL,XMHE36X52X4J (Ref # 92049)	92049-1162	1
SEAL-OIL,STEERING STEM (Ref # 92049A)	92049-1214	1
BEARING-ROLLER,HR320/28XJ (Ref # 92116)	92116-1009	1
BEARING-ROLLER,HICAP 32005JR (Ref # 92116A)	92116-1052	1
WASHER,CLAW,18.5X30X2.3 (Ref # 92200)	92200-1357	1
FRAME-COMP,RR,SILVER NO.25 (Ref # 32002)	32002-1918-CE	1
FRAME-COMP,RR,SILVER NO.25 (Ref # 32002A)	32002-1923-CE	1