

# 2016 NINJA® 650 ABS PARTS DIAGRAM

Valve(s)

E1210

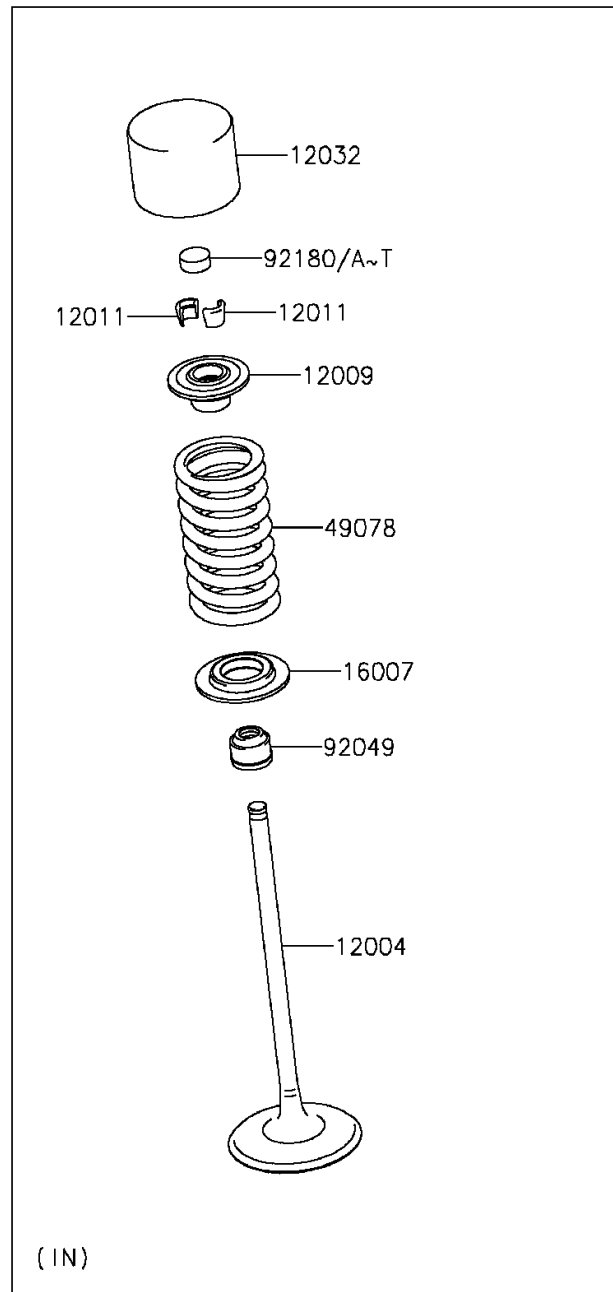
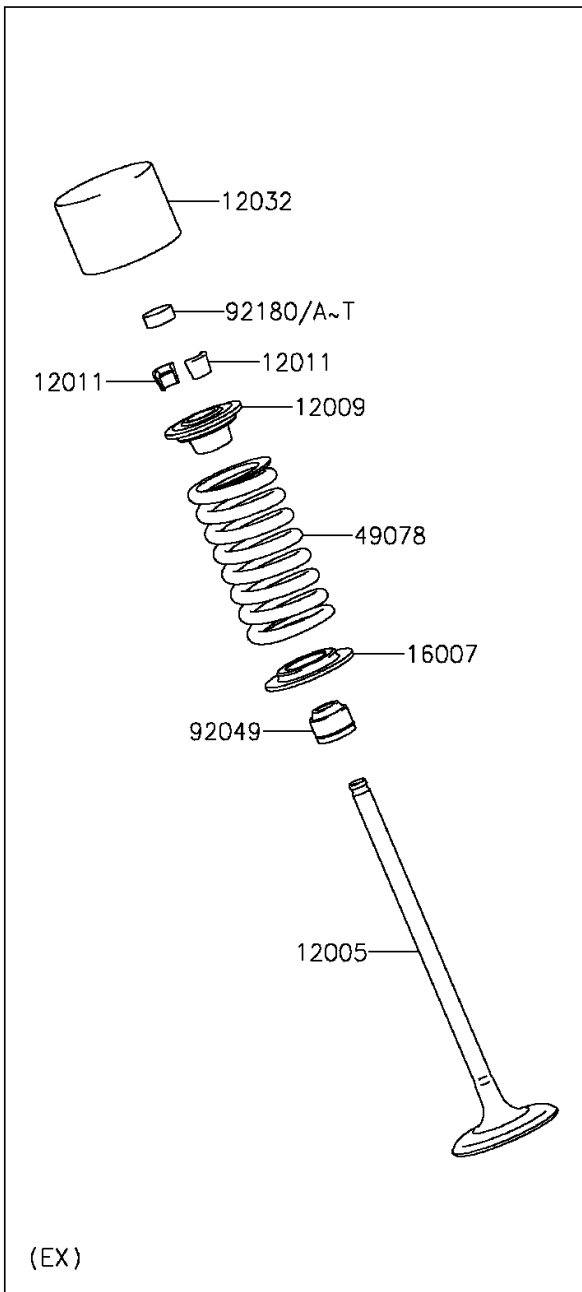

# 2016 NINJA® 650 ABS PARTS LIST

Valve(s)

ITEM NAME	PART NUMBER	QUANTITY
-----------	-------------	----------