

2015 VULCAN® 900 CLASSIC PARTS DIAGRAM

Side Covers/Chain Cover

F2610

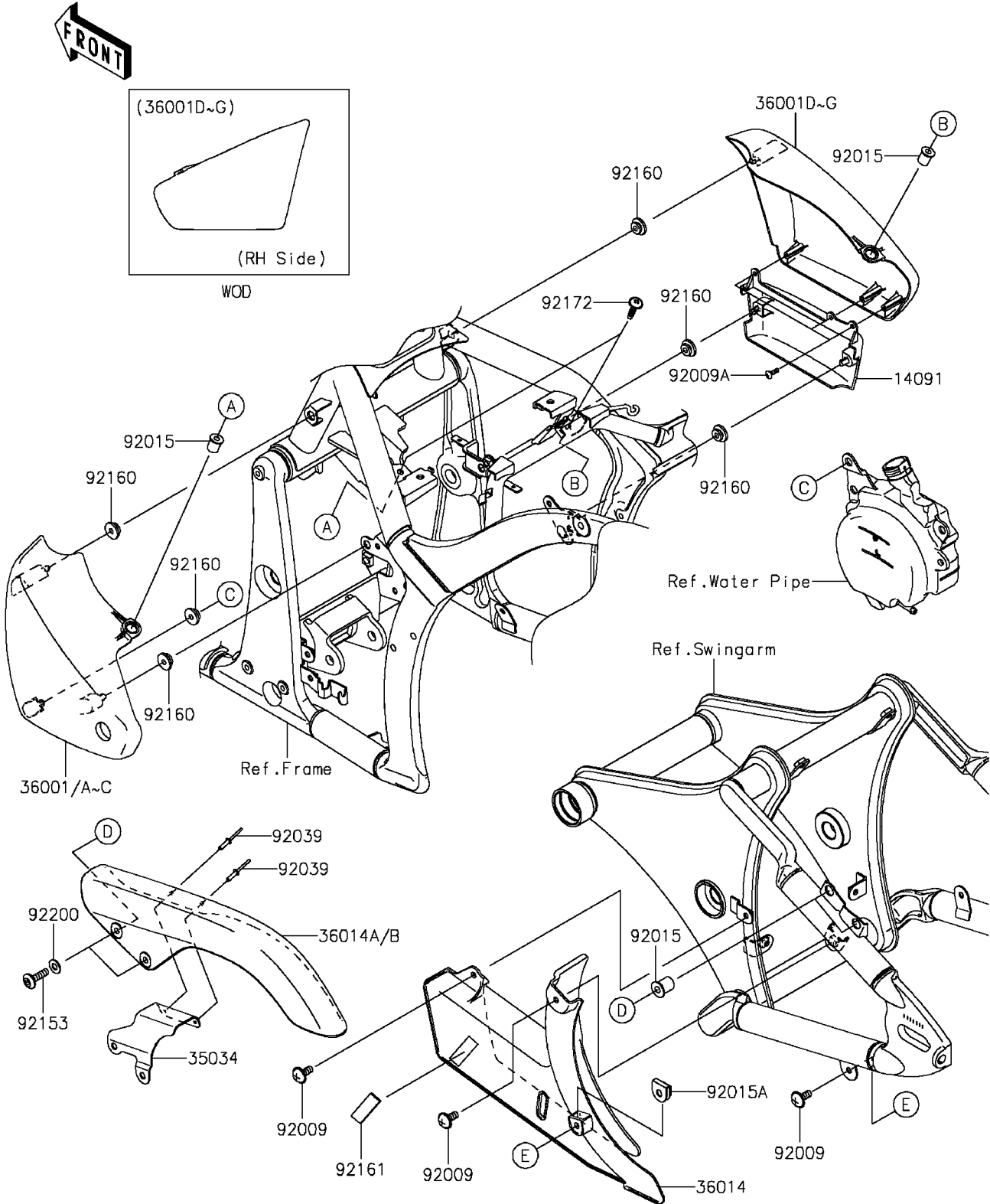

2015 VULCAN® 900 CLASSIC PARTS LIST

Side Covers/Chain Cover

ITEM NAME	PART NUMBER	QUANTITY
-----------	-------------	----------