

2016 VULCAN® 900 CLASSIC PARTS DIAGRAM

Chassis Electrical Equipment

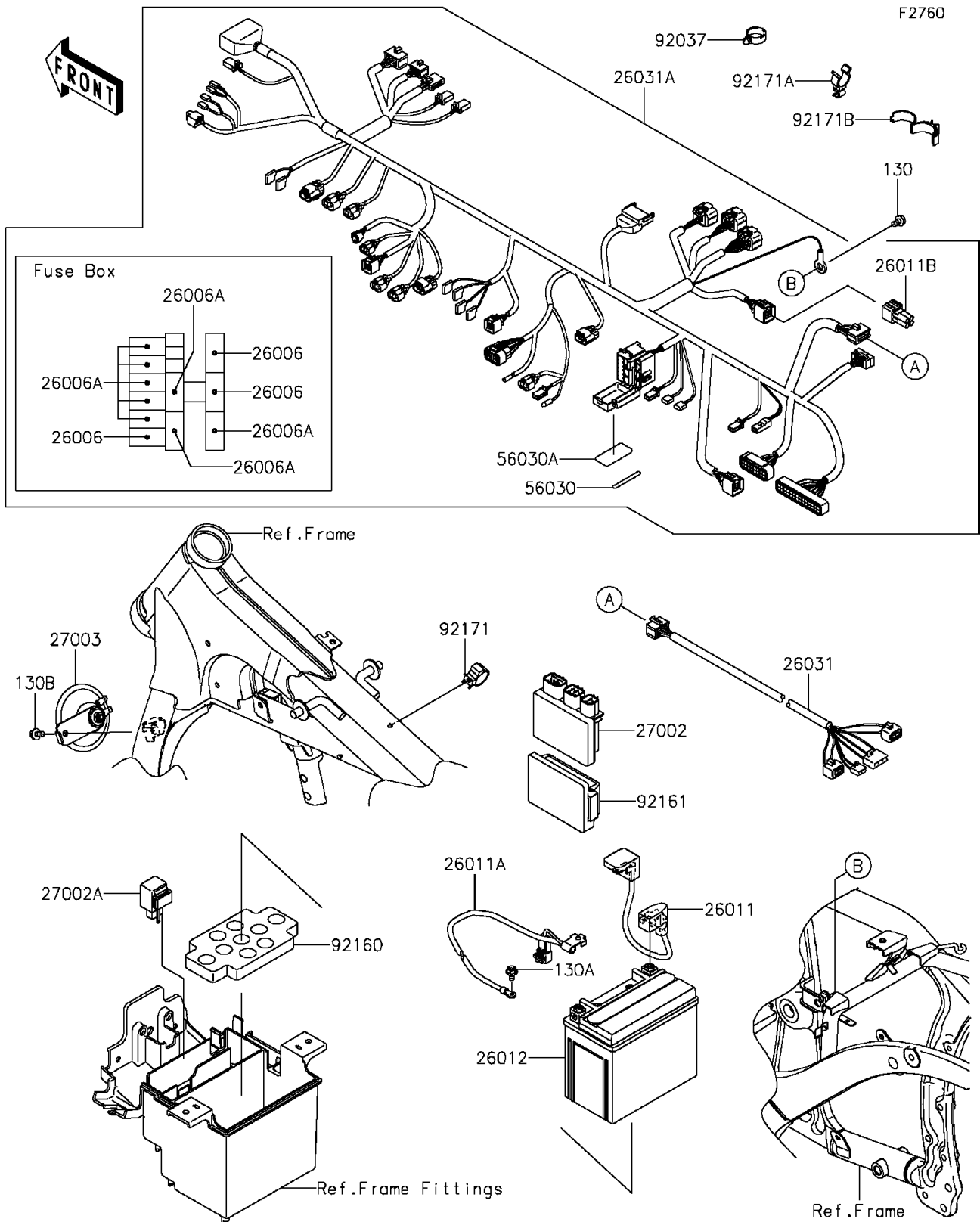

2016 VULCAN® 900 CLASSIC PARTS LIST

Chassis Electrical Equipment

ITEM NAME	PART NUMBER	QUANTITY
-----------	-------------	----------