

# 2014 W800 (European) PARTS DIAGRAM

Chassis Electrical Equipment

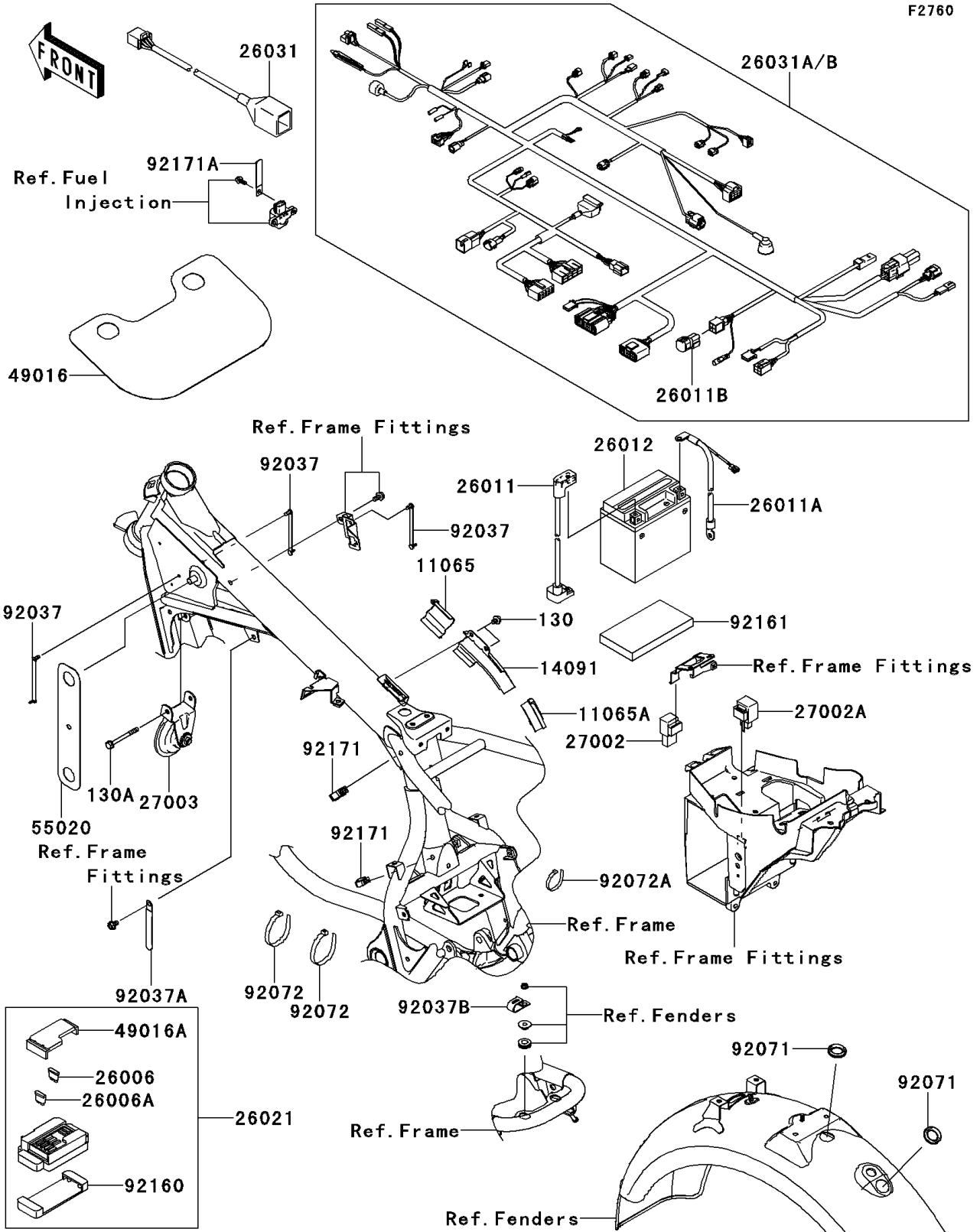

## 2014 W800 (European) PARTS LIST

### Chassis Electrical Equipment

ITEM NAME	PART NUMBER	QUANTITY
BOLT-FLANGED,6X8 (Ref # 130)	130BB0608	2
BOLT-FLANGED,6X60 (Ref # 130A)	130BB0660	1
CAP,HARNESS COVER,FR (Ref # 11065)	11065-1141	1
CAP,HARNESS COVER,RR (Ref # 11065A)	11065-1142	1
COVER,HARNESS (Ref # 14091)	14091-1274	1
FUSE,BLADE,30A,GREEN (Ref # 26006)	26006-1067	1
FUSE,10A-R (Ref # 26006A)	26006-1068	7
WIRE-LEAD,BATTERY(+) (Ref # 26011)	26011-0313	1
WIRE-LEAD,BATTERY(-) (Ref # 26011A)	26011-0314	1
WIRE-LEAD (Ref # 26011B)	26011-0741	1
BATTERY,YTX12-BS,12V 10AH (Ref # 26012)	26012-0094	1
JUNCTION BOX (Ref # 26021)	26021-0053	1
HARNESS,RR (Ref # 26031)	26031-0991	1
HARNESS,MAIN (Ref # 26031B)	26031-1663	1
RELAY-ASSY (Ref # 27002)	27002-1062	1
RELAY-ASSY,TURN SIGNAL (Ref # 27002A)	27002-1101	1
HORN (Ref # 27003)	27003-0080	1
COVER-SEAL (Ref # 49016)	49016-0571	1
COVER-SEAL,FUSE (Ref # 49016A)	49016-0574	1
GUARD (Ref # 55020)	55020-1985	1
CLAMP,SPEED,L=80.5 (Ref # 92037)	92037-1903	3
CLAMP (Ref # 92037A)	92037-1993	1
CLAMP (Ref # 92037B)	92037-2081	1
GROMMET,18X29X5 (Ref # 92071)	92071-0054	2
BAND,L=140 (Ref # 92072)	92072-1293	2
BAND,L=100 (Ref # 92072A)	92072-3875	1
DAMPER,JUNCTION BOX (Ref # 92160)	92160-1650	1
DAMPER,BATTERY (Ref # 92161)	92161-0018	1
CLAMP,CLIP,DIA=20 (Ref # 92171)	92171-0068	2

## 2014 W800 (European) PARTS LIST

Chassis Electrical Equipment

ITEM NAME	PART NUMBER	QUANTITY
CLAMP,L=60 (Ref # 92171A)	92171-0652	1