

# 1997 900 STX PARTS DIAGRAM

## Hull Fittings

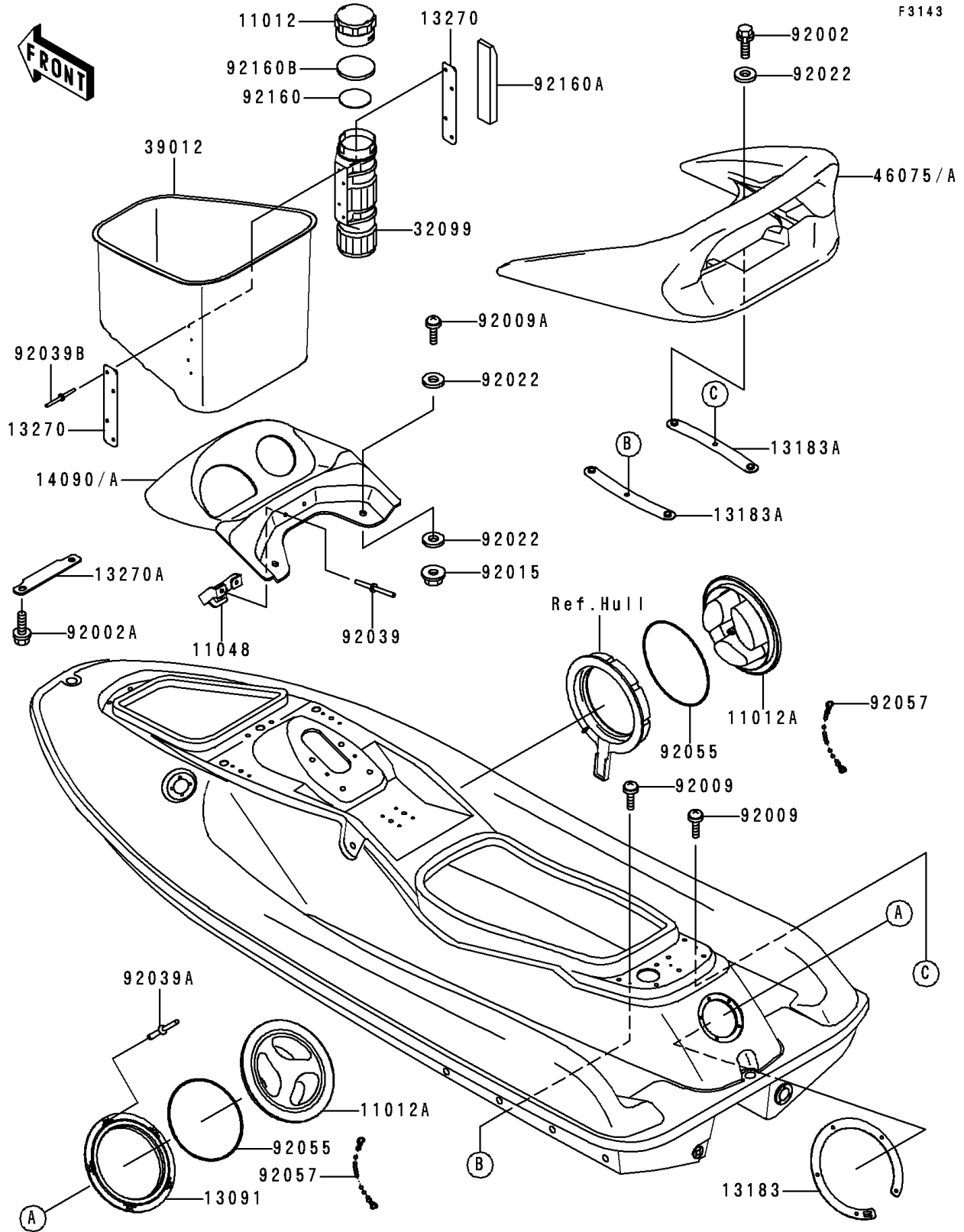

# 1997 900 STX PARTS LIST

## Hull Fittings

ITEM NAME	PART NUMBER	QUANTITY
CAP,FIRE EXTINGUISHER (Ref # 11012)	11012-3766	1
CAP,STORAGE,J.WHITE (Ref # 11012A)	11012-3797-8U	2
BRACKET,METER COVER (Ref # 11048)	11048-3741	1
HOLDER,STORAGE,J.WHITE (Ref # 13091)	13091-3766-8U	1
PLATE,STORAGE (Ref # 13183)	13183-3804	1
PLATE,TAIL GRIP (Ref # 13183A)	13183-3805	2
PLATE,FIRE EXTINGUISHER (Ref # 13270)	13270-3729	2
PLATE (Ref # 13270A)	13270-3742	1
COVER,METER,F.RED (Ref # 14090)	14090-3796-B1	1
CASE,FIRE EXTINGUISHER (Ref # 32099)	32099-3769	1
CASE-STORAGE (Ref # 39012)	39012-3718	1
GRIP,TAIL,F.RED (Ref # 46075)	46075-3744-6L	1
BOLT,6X25 (Ref # 92002)	92002-3714	4
BOLT,6X12 (Ref # 92002A)	92002-3763	2
SCREW,5X16 (Ref # 92009)	92009-3789	2
SCREW,6X18 (Ref # 92009A)	92009-3805	2
NUT,6MM (Ref # 92015)	92015-3767	2
WASHER,6.5X20X1.5 (Ref # 92022)	92022-3710	8
RIVET,4MM (Ref # 92039)	92039-3703	2
RIVET (Ref # 92039A)	92039-3714	5
RIVET (Ref # 92039B)	92039-3755	4
RING-O,ID=131.6MM (Ref # 92055)	92055-3732	2
CHAIN,COVER,L=100 (Ref # 92057)	92057-3704	2
DAMPER (Ref # 92160)	92160-3814	1
DAMPER (Ref # 92160A)	92160-3821	1
DAMPER (Ref # 92160B)	92160-3899	1