

# 1995 Bayou 220 PARTS DIAGRAM

Drive Shaft/Final Gear

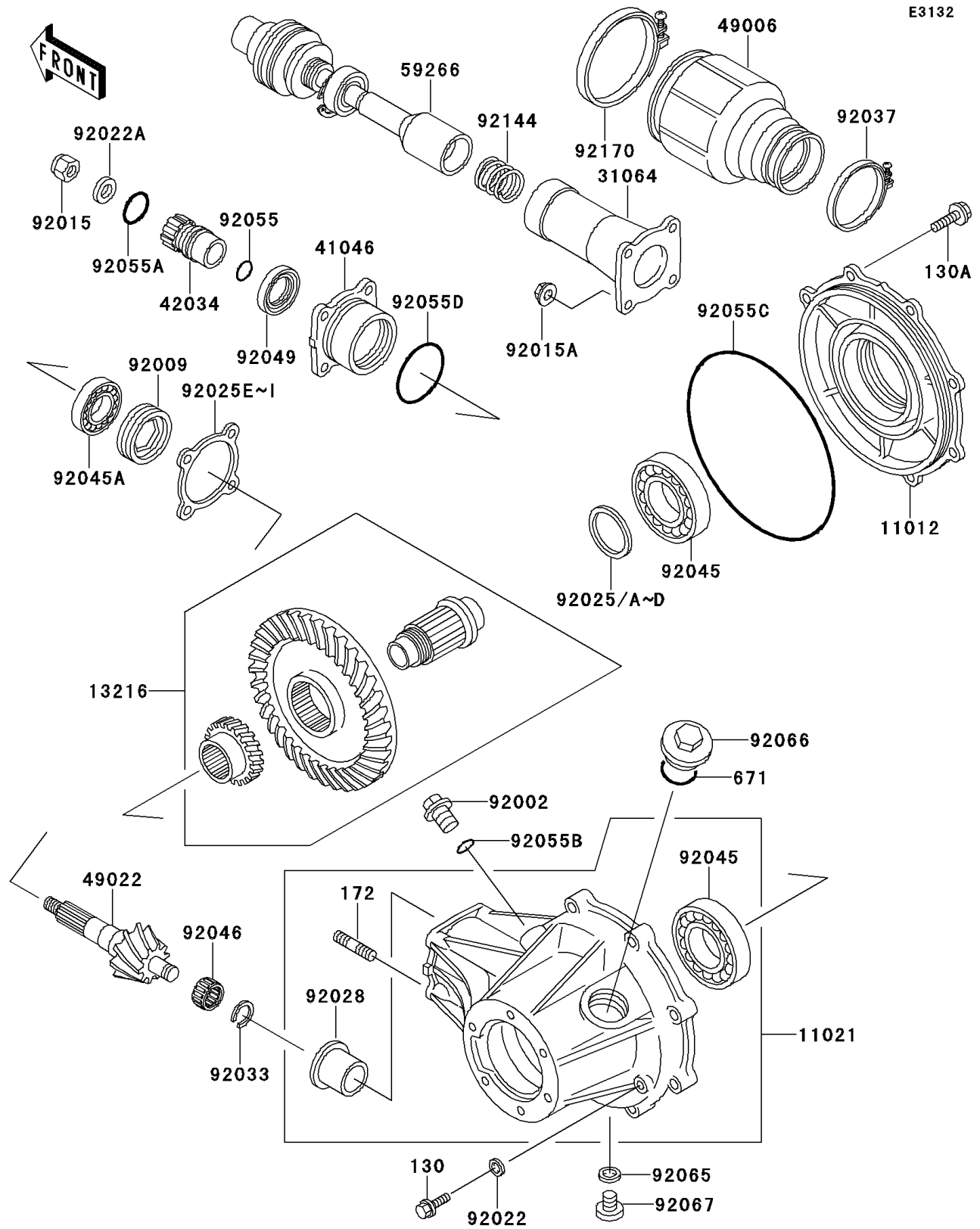

# 1995 Bayou 220 PARTS LIST

## Drive Shaft/Final Gear

ITEM NAME	PART NUMBER	QUANTITY
CAP (Ref # 11012)	11012-1593	1
CASE-ASSY,FRONT BEVEL (Ref # 11021)	11021-1069	1
GEAR-COMP,FINAL (Ref # 13216)	13216-1134	1
PIPE-COMP,FR (Ref # 31064)	31064-1087	1
HOUSING-BEARING (Ref # 41046)	41046-1084	1
COUPLING,DIFFERENTIAL CASE (Ref # 42034)	42034-1078	1
BOOT,DRIVE SHAFT (Ref # 49006)	49006-1240	1
GEAR-BEVEL,10T (Ref # 49022)	49022-1097	1
JOINT-BALL,DRIVE SHAFT (Ref # 59266)	59266-1069	1
BOLT,16X10 (Ref # 92002)	92002-1238	1
SCREW (Ref # 92009)	92009-1475	1
NUT,12MM (Ref # 92015)	92015-1182	1
NUT,8MM (Ref # 92015A)	92015-1402	4
WASHER,6.1X12X1 (Ref # 92022)	92022-077	1
WASHER,12.3X25X3.2 (Ref # 92022A)	92022-1293	1
SHIM,35.3X46X1.00 (Ref # 92025)	92025-1849	AR
SHIM,35.3X46X0.10 (Ref # 92025A)	92025-1850	AR
SHIM,35.3X46X0.15 (Ref # 92025B)	92025-1851	AR
SHIM,35.3X46X0.50 (Ref # 92025C)	92025-1856	AR
SHIM,35.3X46X0.80 (Ref # 92025D)	92025-1857	AR
SHIM,T=1.00 (Ref # 92025E)	92025-1864	AR
SHIM,T=0.10 (Ref # 92025F)	92025-1865	AR
SHIM,T=0.15 (Ref # 92025G)	92025-1866	AR
SHIM,T=0.50 (Ref # 92025H)	92025-1867	AR
SHIM,T=0.80 (Ref # 92025I)	92025-1868	AR
BUSHING (Ref # 92028)	92028-1501	1
RING-SNAP,14X17.5X1.2 (Ref # 92033)	92033-1234	1
CLAMP (Ref # 92037)	92037-1523	1
BEARING-BALL (Ref # 92045)	92045-1110	2

# 1995 Bayou 220 PARTS LIST

## Drive Shaft/Final Gear

ITEM NAME	PART NUMBER	QUANTITY
BEARING-BALL (Ref # 92045A)	92045-1112	1
BEARING-NEEDLE,K15X21X15 (Ref # 92046)	92046-1173	1
SEAL-OIL (Ref # 92049)	92049-1231	1
RING-O,17.5X1.5 (Ref # 92055)	92055-022	1
RING-O,27MM (Ref # 92055A)	92055-1119	1
RING-O,ID=13.8 (Ref # 92055B)	92055-1141	1
RING-O,154MM (Ref # 92055C)	92055-1165	1
RING-O (Ref # 92055D)	92055-3018	1
GASKET,10.5X16X1,DRAIN PLUG (Ref # 92065)	92065-058	1
PLUG (Ref # 92066)	92066-1284	1
PLUG,DRAIN,10X12 (Ref # 92067)	92067-001	1
BOLT-FLANGED,6X8 (Ref # 130)	130B0608	1
BOLT-FLANGED (Ref # 130A)	130P0825	8
BOLT-STUD,8X25 (Ref # 172)	172G0825	4
O RING,30MM (Ref # 671)	671B2530	1
SPRING,DRIVE SHAFT (Ref # 92144)	92144-1235	1
CLAMP (Ref # 92170)	92170-1149	1