

# 1996 Bayou 220 PARTS DIAGRAM

Brake Pedal

F2260

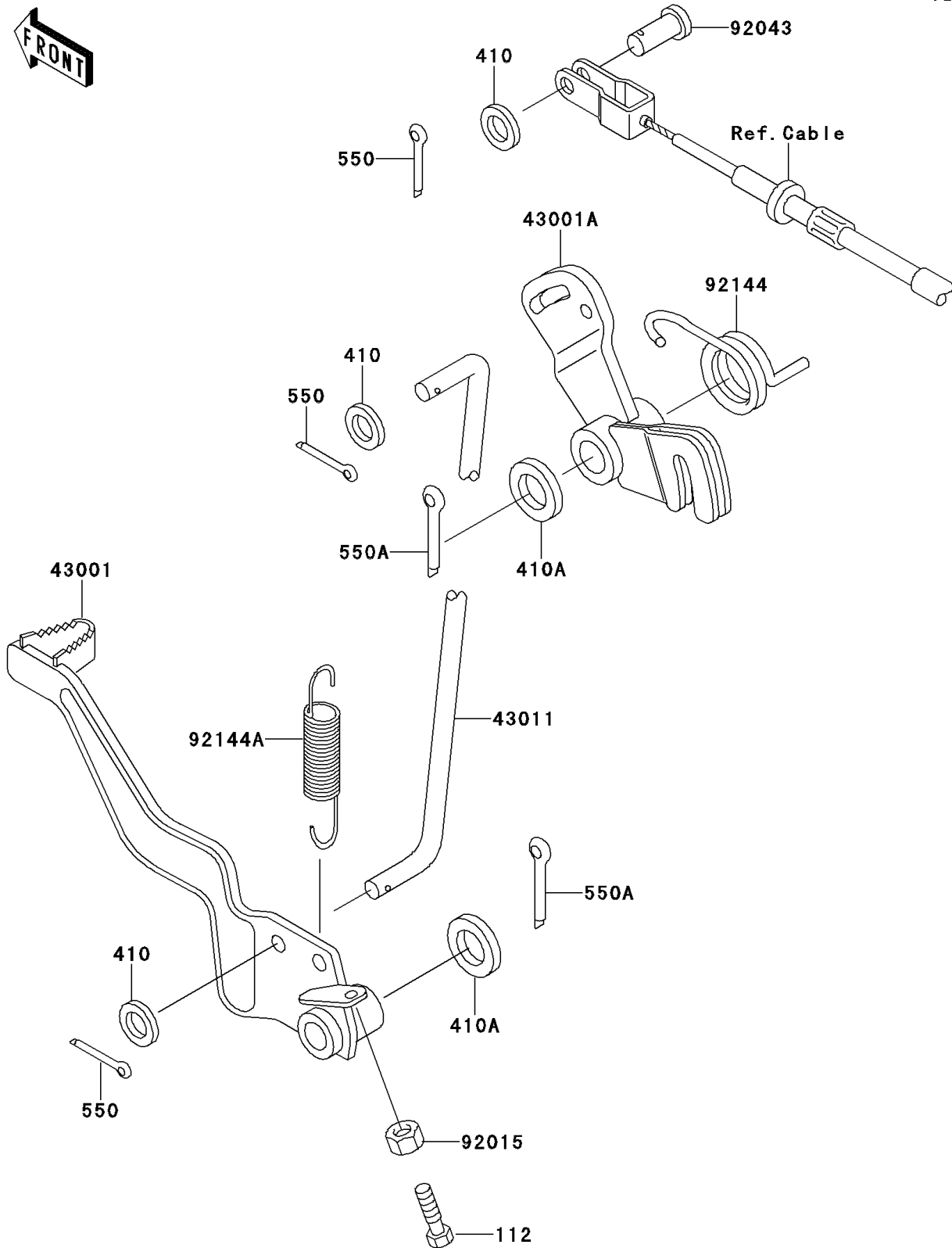

# 1996 Bayou 220 PARTS LIST

## Brake Pedal

ITEM NAME	PART NUMBER	QUANTITY
BOLT-UPSET (Ref # 112)	112D0622	1
WASHER-PLAIN-SMALL,6MM (Ref # 410)	410B0600	3
WASHER-PLAIN-SMALL,14MM (Ref # 410A)	410B1400	2
PIN-COTTER,2.0X15 (Ref # 550)	550D2015	3
PIN-COTTER,2.5X25 (Ref # 550A)	550D2525	2
LEVER-BRAKE,PEDAL (Ref # 43001)	43001-1230	1
LEVER-BRAKE (Ref # 43001A)	43001-1288	1
ROD-BRAKE (Ref # 43011)	43011-1138	1
NUT,6MM (Ref # 92015)	92015-1410	1
PIN,6X14.5 (Ref # 92043)	92043-125	1
SPRING,BRAKE LEVER RETURN (Ref # 92144)	92144-1165	1
SPRING,BRAKE PEDAL RETURN (Ref # 92144A)	92144-1266	1