

1995 Bayou 220 PARTS DIAGRAM

Labels

F2860

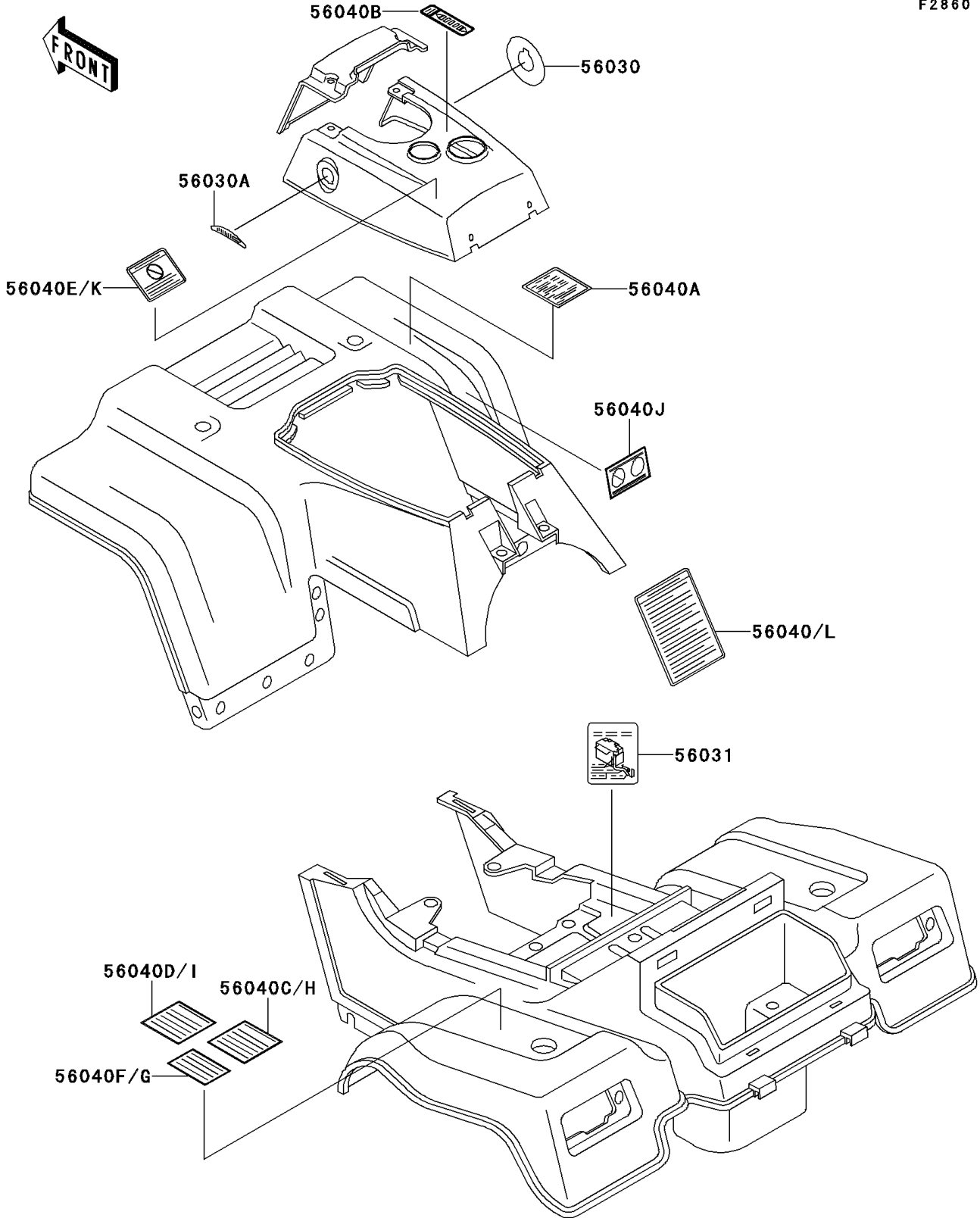

1995 Bayou 220 PARTS LIST

Labels

ITEM NAME	PART NUMBER	QUANTITY
LABEL,IGNITION SWITCH (Ref # 56030)	56030-1086	1
LABEL,REVERSE (Ref # 56030A)	56030-1102	1
LABEL-MANUAL,BATTERY VENT (Ref # 56031)	56031-1533	1
LABEL-WARNING,SERIOUS INJURY (Ref # 56040)	56040-1256	1
LABEL-WARNING,TRANSPORT (Ref # 56040A)	56040-1261	1
LABEL-WARNING,SHIFT PATTERN (Ref # 56040B)	56040-1262	1
LABEL-WARNING,TIRE PRESSURE (Ref # 56040C)	56040-1272	1
LABEL-WARNING,LOAD (Ref # 56040D)	56040-1273	1
LABEL-WARNING,UNDER 16 (Ref # 56040E)	56040-1276	1
LABEL-WARNING,NO PASSENGER (Ref # 56040F)	56040-1277	1
LABEL-WARNING,NO PASSENGER (Ref # 56040G)	56040-1280	1
LABEL-WARNING,TIRE PRESSURE (Ref # 56040H)	56040-1281	1
LABEL-WARNING,LOAD CAPACITY (Ref # 56040I)	56040-1282	1
LABEL-WARNING,TRANSPORT (Ref # 56040J)	56040-1283	1
LABEL-WARNING,AGE (Ref # 56040K)	56040-1325	1
LABEL-WARNING,GENERAL (Ref # 56040L)	56040-1326	1