

1999 Bayou 220 PARTS DIAGRAM

Crankshaft

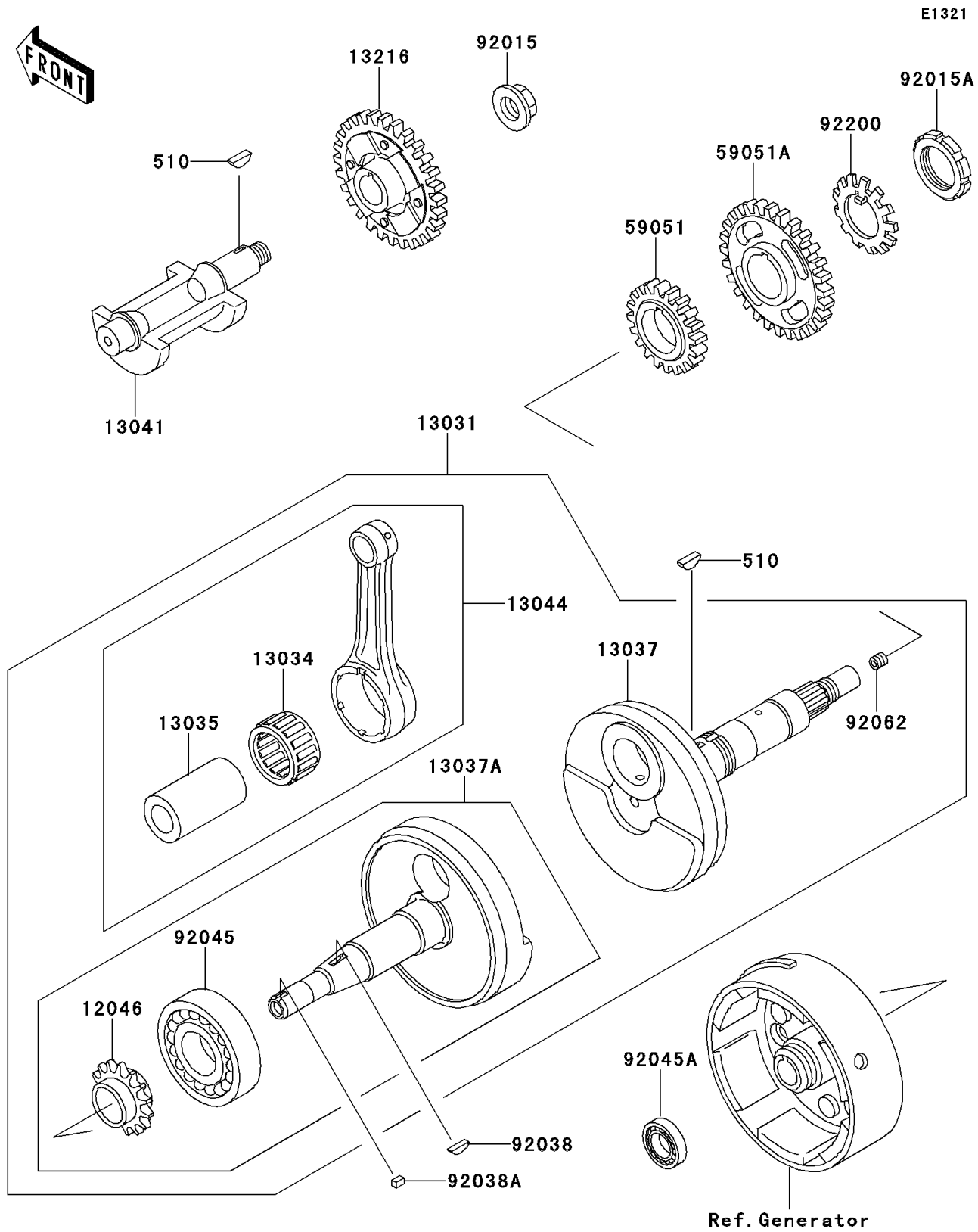

1999 Bayou 220 PARTS LIST

Crankshaft

ITEM NAME	PART NUMBER	QUANTITY
KEY-WOODRUFF (Ref # 510)	510A5100	2
SPROCKET,CAM CHAIN,19T (Ref # 12046)	12046-1152	1
CRANKSHAFT-COMP (Ref # 13031)	13031-1373	1
BEARING-BIG END (Ref # 13034)	13034-1098	1
PIN-CRANK (Ref # 13035)	13035-1063	1
CRANKSHAFT,RH (Ref # 13037)	13037-1478	1
CRANKSHAFT,LH (Ref # 13037A)	13037-5085	1
BALANCER (Ref # 13041)	13041-1127	1
SET-CONNECTING ROD (Ref # 13044)	13044-5086	1
GEAR-COMP,BALANCER (Ref # 13216)	13216-1184	1
GEAR,OIL PUMP,30T (Ref # 59051)	59051-1187	1
GEAR-SPUR,39T (Ref # 59051A)	59051-1188	1
NUT,16MM (Ref # 92015)	92015-1465	1
NUT,PUMP GEAR,30MM (Ref # 92015A)	92015-1511	1
KEY,WOODRUFF (Ref # 92038)	92038-001	1
KEY,SUNK (Ref # 92038A)	92038-1051	1
BEARING-BALL (Ref # 92045)	92045-1172	1
BEARING-BALL,6903C3 (Ref # 92045A)	92045-1266	1
NOZZLE,8X8,SILVER (Ref # 92062)	92062-1082	1
WASHER,PUMP GEAR (Ref # 92200)	92200-1203	1