

1999 Bayou 220 PARTS DIAGRAM

Recoil Starter

E3040

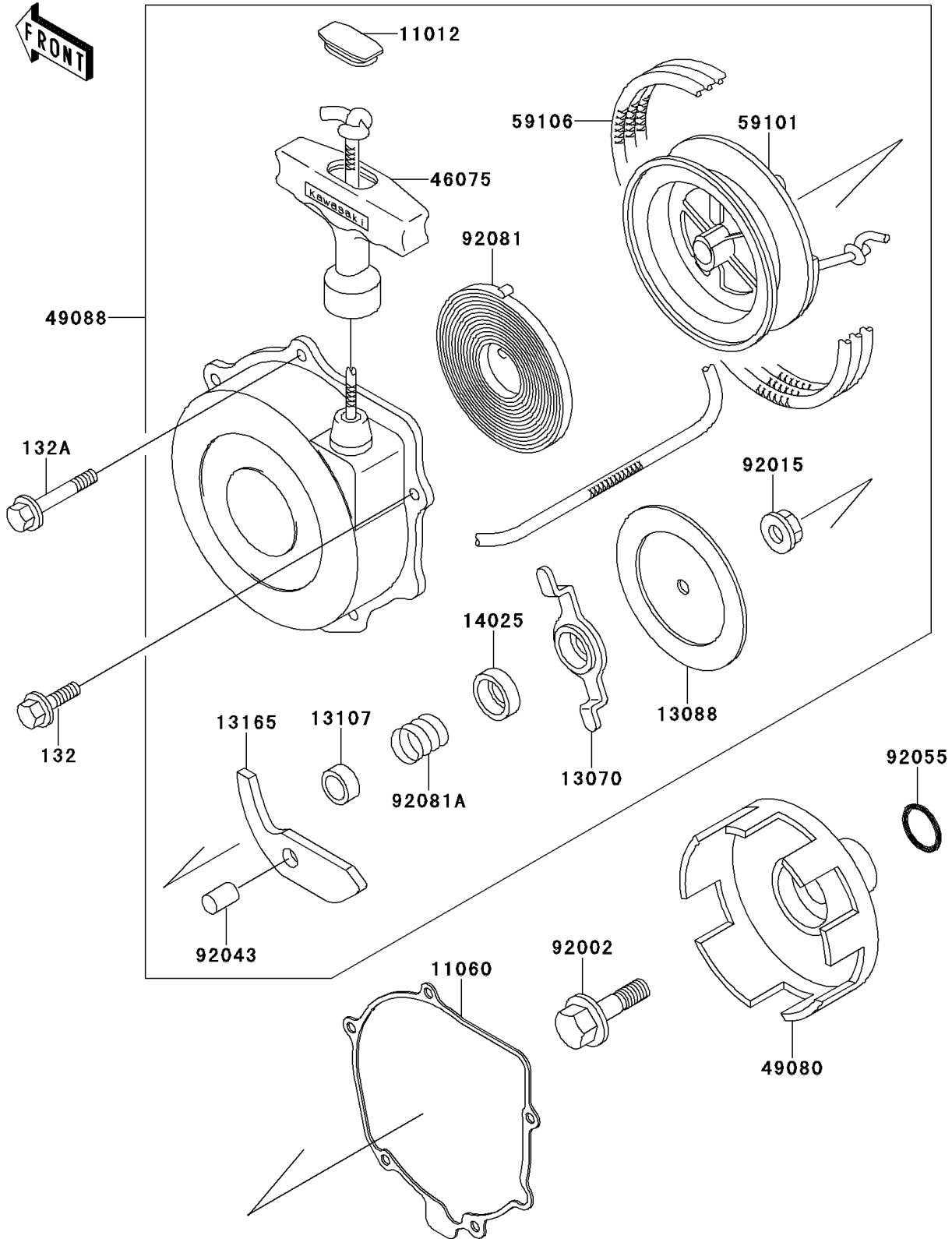

1999 Bayou 220 PARTS LIST

Recoil Starter

ITEM NAME	PART NUMBER	QUANTITY
BOLT-FLANGED-SMALL (Ref # 132)	132J0614	4
BOLT-FLANGED-SMALL (Ref # 132A)	132J0680	1
CAP,RECOIL GRIP (Ref # 11012)	11012-1420	1
GASKET,RECOIL STARTER (Ref # 11060)	11060-1650	1
GUIDE,RECOIL (Ref # 13070)	13070-1123	1
PLATE-FRICTION,RECOIL (Ref # 13088)	13088-1059	1
SHAFT,RECOIL (Ref # 13107)	13107-1129	1
PAWL,RECOIL (Ref # 13165)	13165-1110	1
COVER,RECOIL (Ref # 14025)	14025-1966	1
GRIP,RECOIL (Ref # 46075)	46075-1073	1
PULLEY-STARTING (Ref # 49080)	49080-1051	1
STARTER-RECOIL (Ref # 49088)	49088-1054	1
REEL (Ref # 59101)	59101-1105	1
ROPE,RECOIL (Ref # 59106)	59106-1102	1
BOLT,FLANGED,10X40 (Ref # 92002)	92002-1296	1
NUT,6MM (Ref # 92015)	92015-1464	1
PIN,RECOIL (Ref # 92043)	92043-1259	1
RING-O,16.8MM (Ref # 92055)	92055-1235	1
SPRING,RECOIL (Ref # 92081)	92081-1772	1
SPRING (Ref # 92081A)	92081-1773	1