

1999 900 STX PARTS DIAGRAM

Crankcase

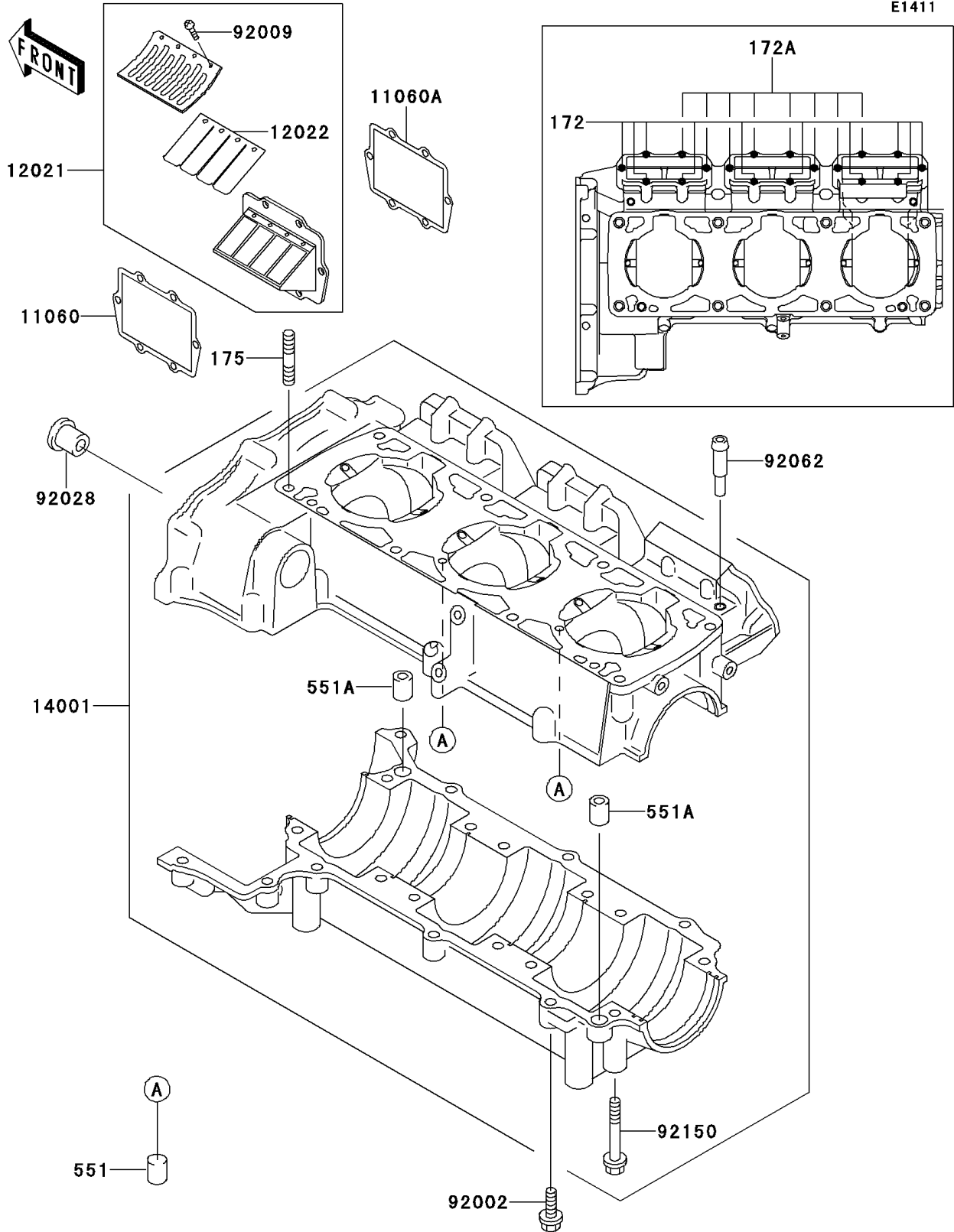

1999 900 STX PARTS LIST

Crankcase

ITEM NAME	PART NUMBER	QUANTITY
BOLT-STUD (Ref # 172)	172R0620	10
BOLT-STUD (Ref # 172A)	172R0630	8
BOLT-STUD-FINE (Ref # 175)	175R1035	8
PIN-DOWEL (Ref # 551)	551R0612	2
PIN-DOWEL (Ref # 551A)	551R1012	2
GASKET, REED VALVE (Ref # 11060)	11060-3717	3
GASKET, REED VALVE (Ref # 11060A)	11060-3757	3
VALVE-ASSY-REED (Ref # 12021)	12021-3709	3
VALVE-REED (Ref # 12022)	12022-3703	6
SET-CRANKCASE (Ref # 14001)	14001-5365	1
BOLT, 6X30 (Ref # 92002)	92002-3726	9
SCREW, 3X6 (Ref # 92009)	92009-1371	24
BUSHING (Ref # 92028)	92028-3718	1
NOZZLE (Ref # 92062)	92062-3705	1
BOLT, 8X65 (Ref # 92150)	92150-3708	12