

# 1988 KD80 PARTS DIAGRAM

Cylinder Head/Cylinder

E1110-0046

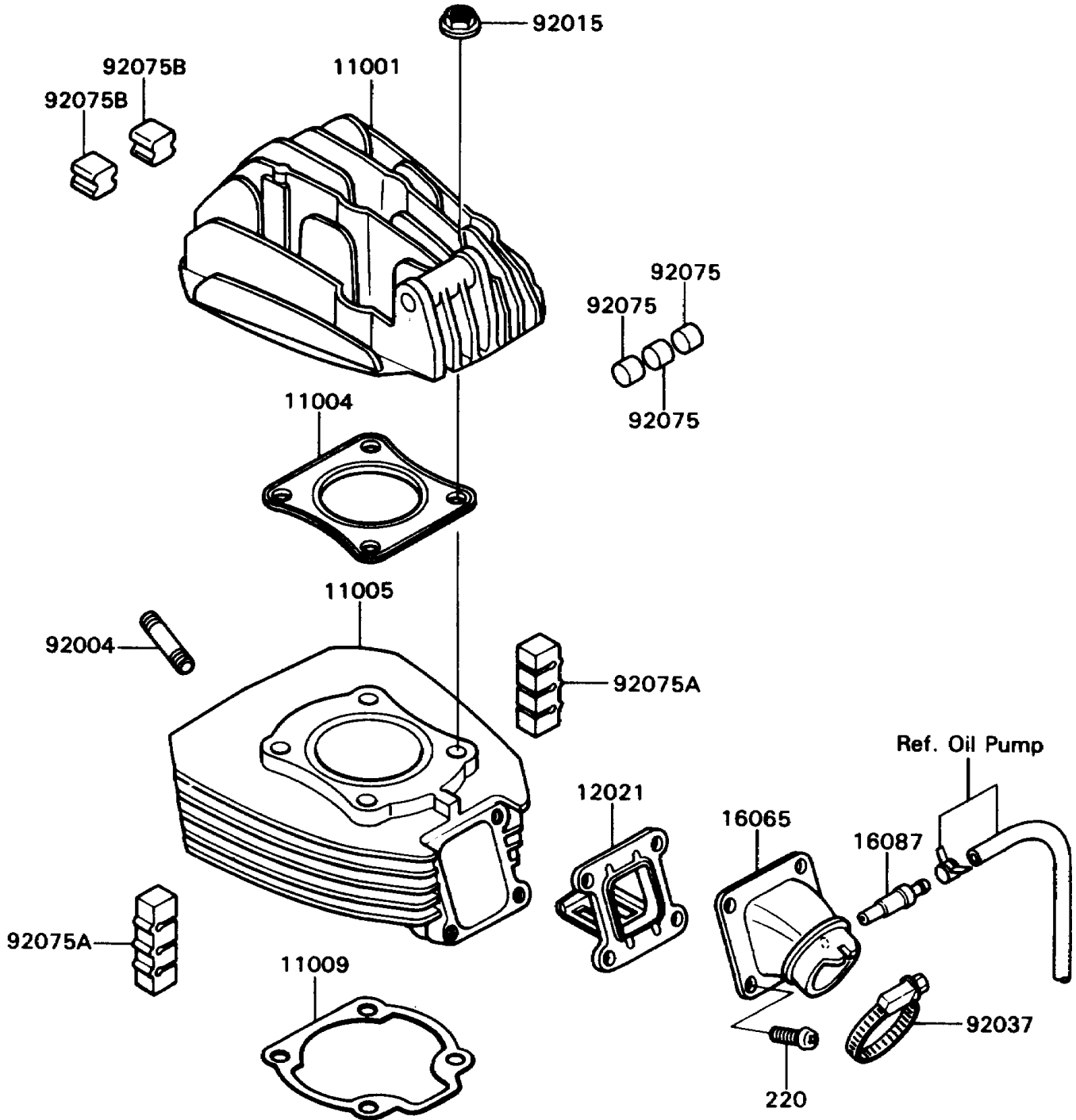

## 1988 KD80 PARTS LIST

### Cylinder Head/Cylinder

ITEM NAME	PART NUMBER	QUANTITY
HEAD-CYLINDER (Ref # 11001)	11001-1285	1
GASKET-HEAD (Ref # 11004)	11004-1179	1
CYLINDER-ENGINE (Ref # 11005)	11005-1546	1
GASKET,CYLINDER BASE (Ref # 11009)	11009-1292	1
VALVE-ASSY-REED (Ref # 12021)	12021-1009	1
HOLDER-CARBURETOR (Ref # 16065)	16065-1172	1
VALVE-CHECK (Ref # 16087)	16087-1001	1
STUD,6X22.5 (Ref # 92004)	92004-1119	2
NUT,8MM (Ref # 92015)	92015-1143	4
CLAMP,COOLING HOSE (Ref # 92037)	92037-1985	1
DAMPER (Ref # 92075)	92075-1018	3
DAMPER,CYLINDER (Ref # 92075A)	92075-1268	4
DAMPER,CYLINDER HEAD (Ref # 92075B)	92075-1339	10
SCREW-PAN-CROS (Ref # 220)	220X0620	4