

1989 KDX200 PARTS DIAGRAM

Stand

F2190

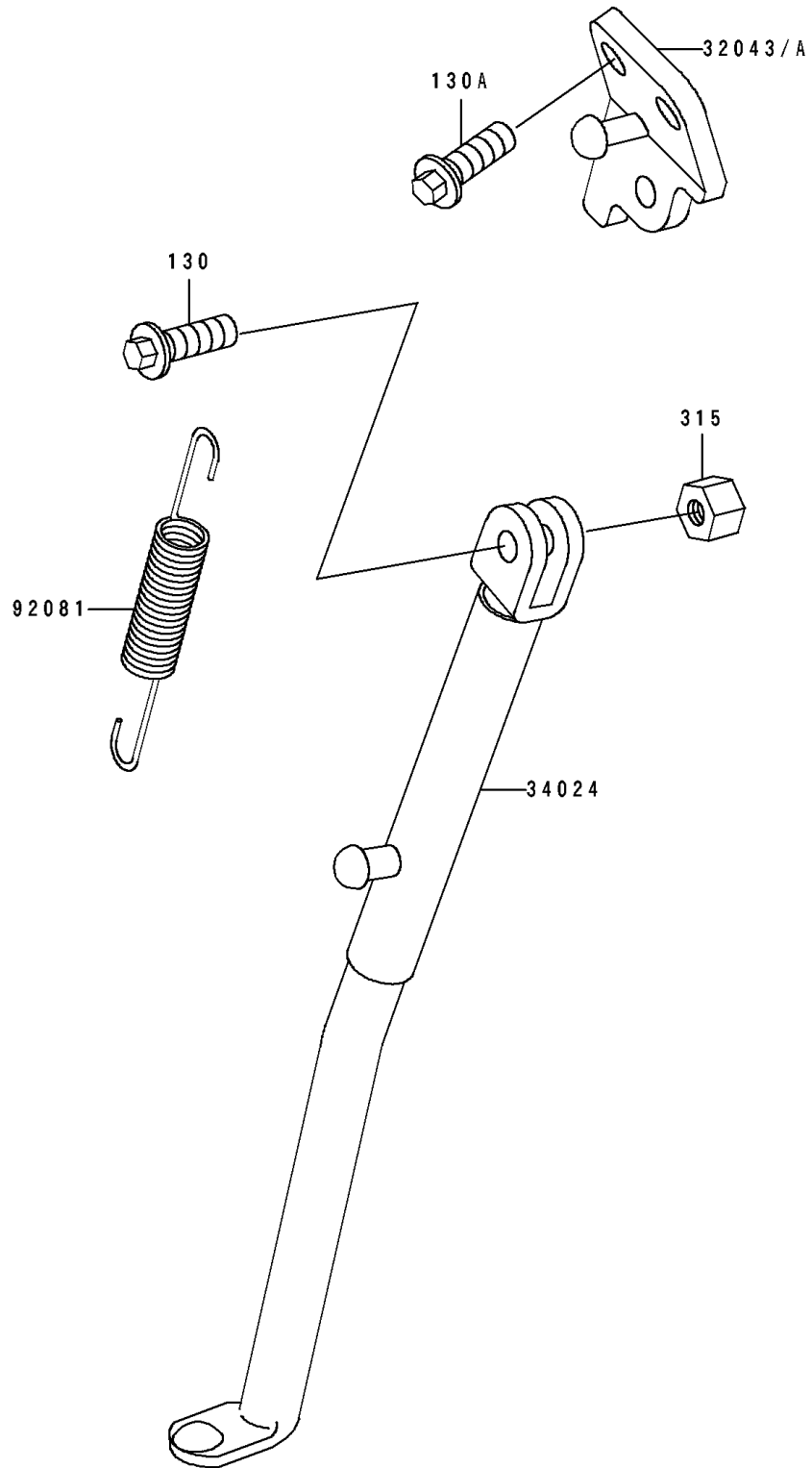

1989 KDX200 PARTS LIST

Stand

ITEM NAME	PART NUMBER	QUANTITY
BRACKET-STAND,SIDE (Ref # 32043)	32043-1336	1
STAND-SIDE (Ref # 34024)	34024-1263	1
SPRING (Ref # 92081)	92081-1419	1
BOLT-FLANGED,10X30 (Ref # 130)	130G1030	1
BOLT-FLANGED (Ref # 130A)	130G1225	2
NUT-HEX-FINE,10MM (Ref # 315)	315B1000	1