

1998 KDX200 PARTS DIAGRAM

Wheels/Tires

F2210

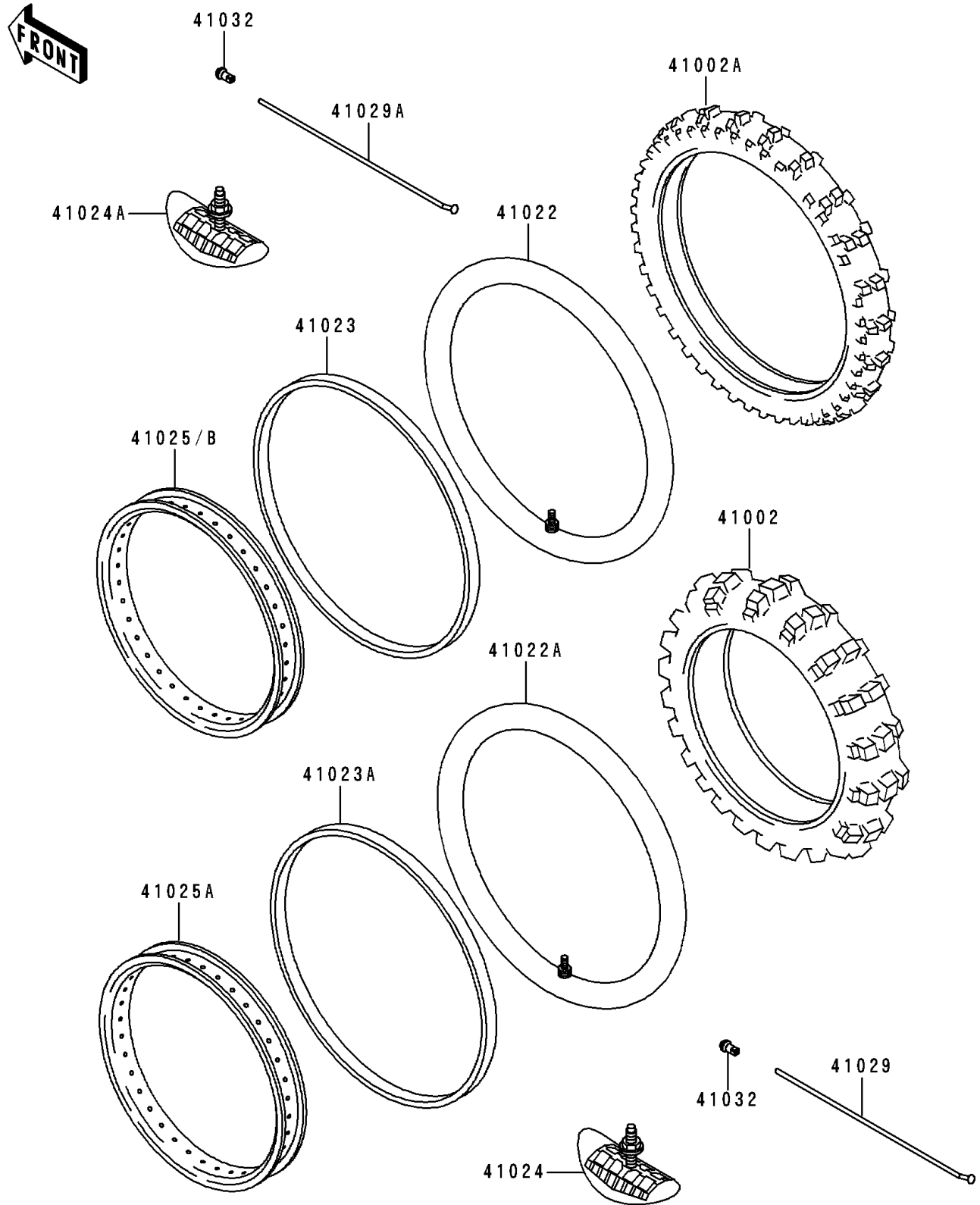

1998 KDX200 PARTS LIST

Wheels/Tires

ITEM NAME	PART NUMBER	QUANTITY
TIRE,RR,100/100-18 59M,K695(D) (Ref # 41002)	41002-1753	1
TIRE,FR,80/100-21 51M,K490J(D) (Ref # 41002A)	41002-1803	1
TUBE-TIRE,80/100-21(D) (Ref # 41022)	41022-1118	1
TUBE-TIRE,100/100-18(D) (Ref # 41022A)	41022-1119	1
BAND-RIM,80/100-21(D) (Ref # 41023)	41023-1069	1
BAND-RIM,100/100-18(D) (Ref # 41023A)	41023-1070	1
STOPPER-RIM,2.15-M(DUNLOP) (Ref # 41024)	41024-009	1
STOPPER-RIM,1.60-M(DUNLOP) (Ref # 41024A)	41024-010	1
RIM,FR,1.60X21 (Ref # 41025)	41025-1286	1
RIM,RR,2.15X18 (Ref # 41025A)	41025-1287	1
SPOKE-INNER,RR,189MMX160D (Ref # 41029)	41029-1199	36
SPOKE-INNER,FR,228MMX165D (Ref # 41029A)	41029-1206	36
NIPPLE-SPOKE (Ref # 41032)	41032-1061	72