

2002 KDX220R PARTS DIAGRAM

Crankcase

E1411

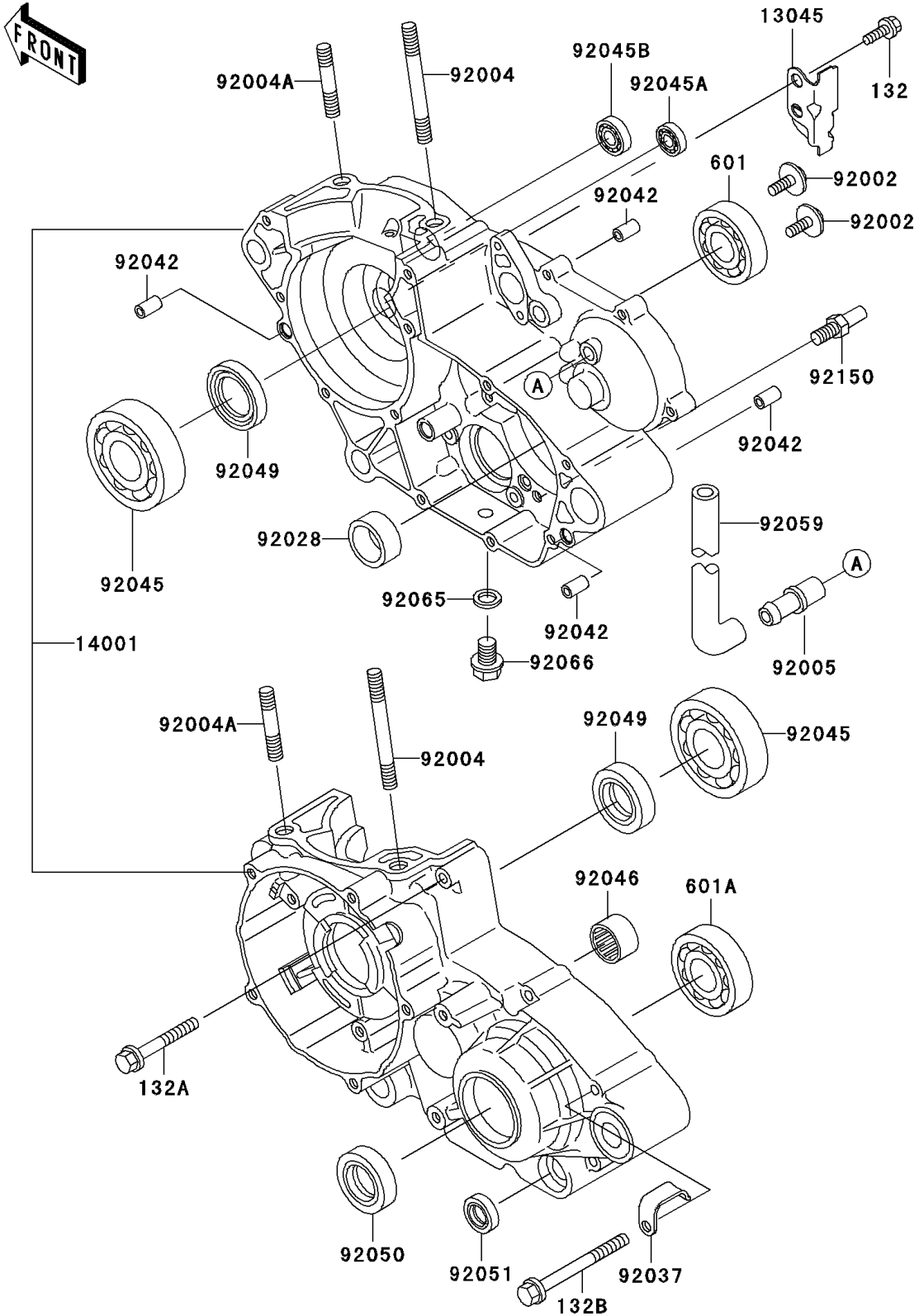

2002 KDX220R PARTS LIST

Crankcase

ITEM NAME	PART NUMBER	QUANTITY
BOLT-FLANGED-SMALL (Ref # 132)	132Y0614	2
BOLT-FLANGED-SMALL (Ref # 132A)	132Y0640	10
BOLT-FLANGED-SMALL (Ref # 132B)	132Y0660	1
BEARING-BALL,#6204C3 (Ref # 601)	601B6204	1
BEARING-BALL,#6205C3 (Ref # 601A)	601B6205	1
RECEIVER-OIL (Ref # 13045)	13045-1056	1
SET-CRANKCASE (Ref # 14001)	14001-1212	1
BOLT,6X16 (Ref # 92002)	92002-1659	2
STUD,8X60 (Ref # 92004)	92004-1132	2
STUD,8X28.5 (Ref # 92004A)	92004-1142	2
FITTING,BREATHER (Ref # 92005)	92005-1210	1
BUSHING,23X30X13 (Ref # 92028)	92028-132	1
CLAMP,HARNESS (Ref # 92037)	92037-1318	1
PIN,DOWEL,6.3X8X14 (Ref # 92042)	92042-007	4
BEARING-BALL,6305JR2C3 (Ref # 92045)	92045-1120	2
BEARING-BALL,626MC3 (Ref # 92045A)	92045-1304	1
BEARING-BALL,608MC3 (Ref # 92045B)	92045-1305	1
BEARING-NEEDLE,#7E-HKS162412-1 (Ref # 92046)	92046-026	1
SEAL-OIL,TBY25X40X6 (Ref # 92049)	92049-1365	2
SEAL-OIL,TB3040 (Ref # 92050)	92050-033	1
SEAL-OIL,TB13225.5 (Ref # 92051)	92051-005	1
TUBE,5X9X400,BLUE (Ref # 92059)	92059-1805	1
GASKET,10.5X16X1 (Ref # 92065)	92065-058	1
PLUG,10MM (Ref # 92066)	92066-1334	1
BOLT,RETURN SPRING (Ref # 92150)	92150-1467	1