

1992 KDX250 PARTS DIAGRAM

Cylinder Head/Cylinder

E1110

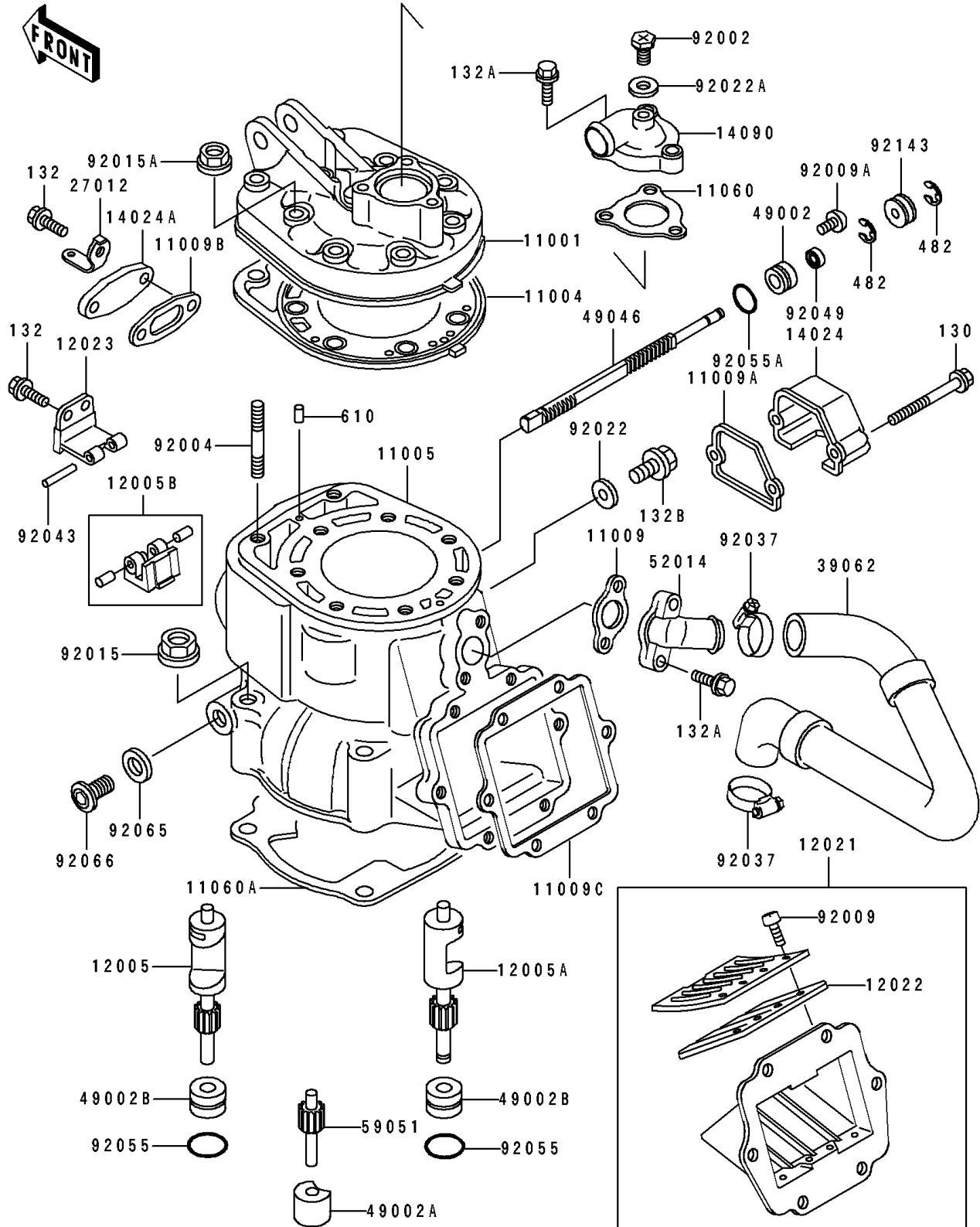

1992 KDX250 PARTS LIST

Cylinder Head/Cylinder

ITEM NAME	PART NUMBER	QUANTITY
HEAD-CYLINDER (Ref # 11001)	11001-1372	1
GASKET-HEAD,T=0.46 (Ref # 11004)	11004-1215	1
CYLINDER-ENGINE (Ref # 11005)	11005-1647	1
GASKET,ELBOW (Ref # 11009)	11009-1935	1
GASKET,GOVERNOR COVER (Ref # 11009A)	11009-1946	1
GASKET,VALVE COVER (Ref # 11009B)	11009-1948	1
GASKET,REED VALVE (Ref # 11009C)	11009-1950	1
GASKET,THERMOSTAT COVER (Ref # 11060)	11060-1102	1
GASKET,CYLINDER BASE (Ref # 11060A)	11060-1147	1
VALVE-EXHAUST,LH (Ref # 12005)	12005-1140	1
VALVE-EXHAUST,RH (Ref # 12005A)	12005-1141	1
VALVE-EXHAUST,CENTER (Ref # 12005B)	12005-1142	1
VALVE-ASSY-REED (Ref # 12021)	12021-1070	1
VALVE-REED (Ref # 12022)	12022-1017	2
HOLDER-VALVE (Ref # 12023)	12023-1055	1
COVER,GOVERNOR (Ref # 14024)	14024-1585	1
COVER,CENTER VALVE (Ref # 14024A)	14024-1588	1
COVER,THERMOSTAT (Ref # 14090)	14090-1053	1
HOOK (Ref # 27012)	27012-1423	1
HOSE-COOLING,PUMP-CYLINDER (Ref # 39062)	39062-1365	1
GUIDE-VALVE (Ref # 49002)	49002-1087	1
GUIDE-VALVE,IDLE GEAR (Ref # 49002A)	49002-1110	1
GUIDE-VALVE (Ref # 49002B)	49002-1111	2
ROD-GOVERNOR (Ref # 49046)	49046-1063	1
ELBOW (Ref # 52014)	52014-1077	1
GEAR-SPUR,IDLE (Ref # 59051)	59051-1194	1
BOLT,6X10 (Ref # 92002)	92002-1222	1
STUD,8X32 (Ref # 92004)	92004-1197	9
SCREW,3X6 (Ref # 92009)	92009-1371	8

1992 KDX250 PARTS LIST

Cylinder Head/Cylinder

ITEM NAME	PART NUMBER	QUANTITY
SCREW,5X10 (Ref # 92009A)	92009-1502	1
NUT,FLANGED,10MM (Ref # 92015)	92015-077	4
NUT,8MM (Ref # 92015A)	92015-1143	9
WASHER,8.2X14X1 (Ref # 92022)	92022-1488	1
WASHER,6.2X11X1 (Ref # 92022A)	92022-304	1
CLAMP,COOLING HOSE (Ref # 92037)	92037-1589	2
PIN,4X23.8 (Ref # 92043)	92043-1373	1
SEAL-OIL,RSO-5.5X11X4 (Ref # 92049)	92049-1206	1
RING-O,17.5X1.5 (Ref # 92055)	92055-022	2
RING-O,11.5X1.5 (Ref # 92055A)	92055-1387	1
GASKET,12.5X18X1,DRAIN PLUG (Ref # 92065)	92065-073	1
PLUG,12X10 (Ref # 92066)	92066-1222	1
COLLAR (Ref # 92143)	92143-1056	1
BOLT-FLANGED (Ref # 130)	130G0535	2
BOLT-FLANGED-SMALL (Ref # 132)	132G0616	4
BOLT-FLANGED-SMALL (Ref # 132A)	132G0625	5
BOLT-FLANGED-SMALL (Ref # 132B)	132G0810	1
CIRCLIP-TYPE-E,4MM (Ref # 482)	482J4000	2
ROLLER,4X8 (Ref # 610)	610A0408	2