

1994 KDX250 PARTS DIAGRAM

Gear Change Mechanism

E1370

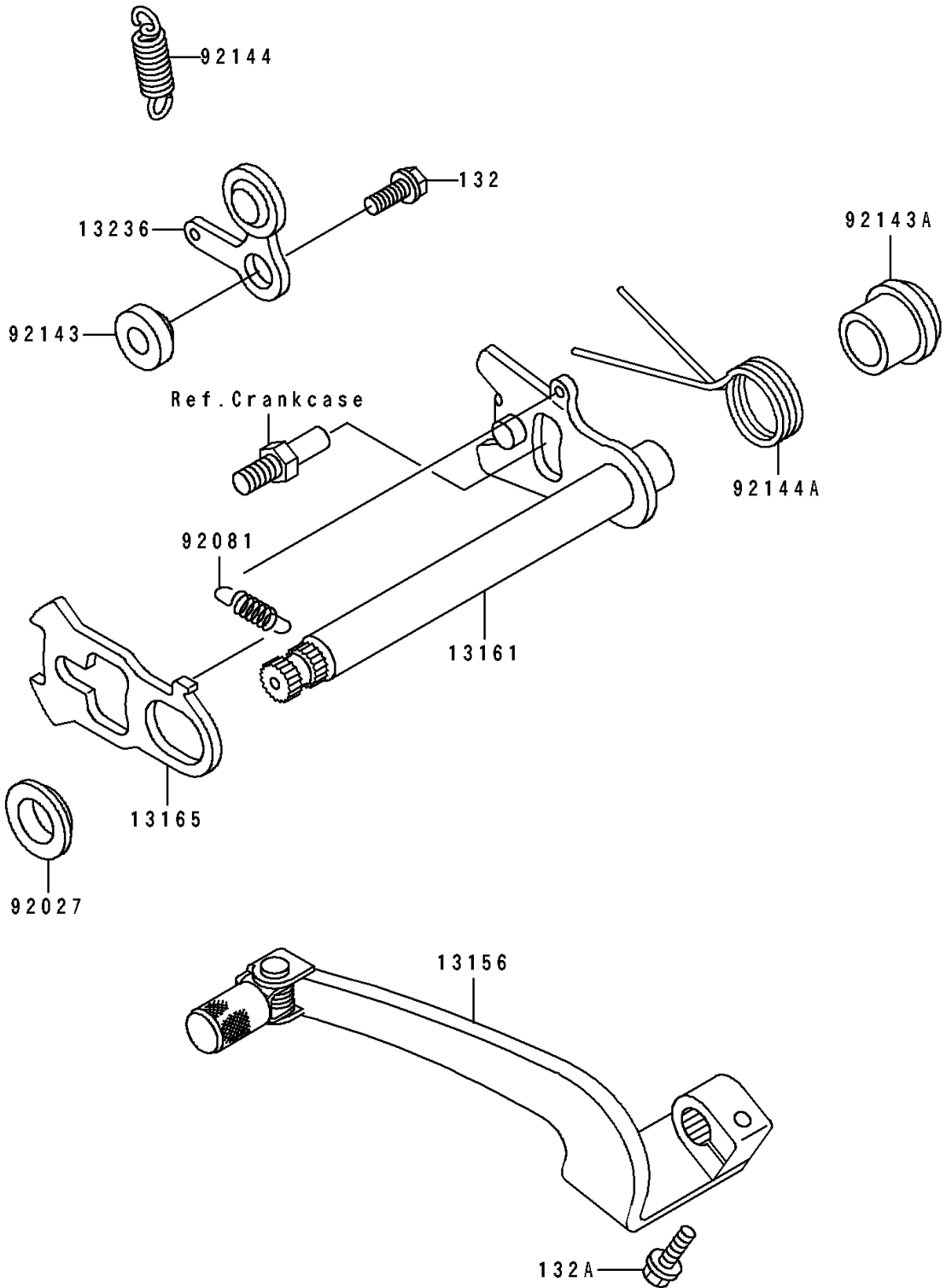

1994 KDX250 PARTS LIST

Gear Change Mechanism

ITEM NAME	PART NUMBER	QUANTITY
LEVER-CHANGE,PEDAL (Ref # 13156)	13156-1339	1
LEVER-COMP-CHANGE SHAFT (Ref # 13161)	13161-1180	1
PAWL,CHANGE LEVER (Ref # 13165)	13165-1119	1
LEVER-COMP,POSITION (Ref # 13236)	13236-1189	1
COLLAR,CHANGE SHAFT,L=5.5 (Ref # 92027)	92027-1512	1
SPRING,CHANGE LEVER (Ref # 92081)	92081-076	1
COLLAR (Ref # 92143)	92143-1055	1
COLLAR,RETURN SPRING (Ref # 92143A)	92143-1498	1
SPRING (Ref # 92144)	92144-1382	1
SPRING,CHANGE SHAFT RETURN (Ref # 92144A)	92144-1485	1
BOLT-FLANGED-SMALL (Ref # 132)	132G0616	1
BOLT-FLANGED-SMALL (Ref # 132A)	132G0625	1