

1992 KDX250 PARTS DIAGRAM

Wheels/Tires

F2210

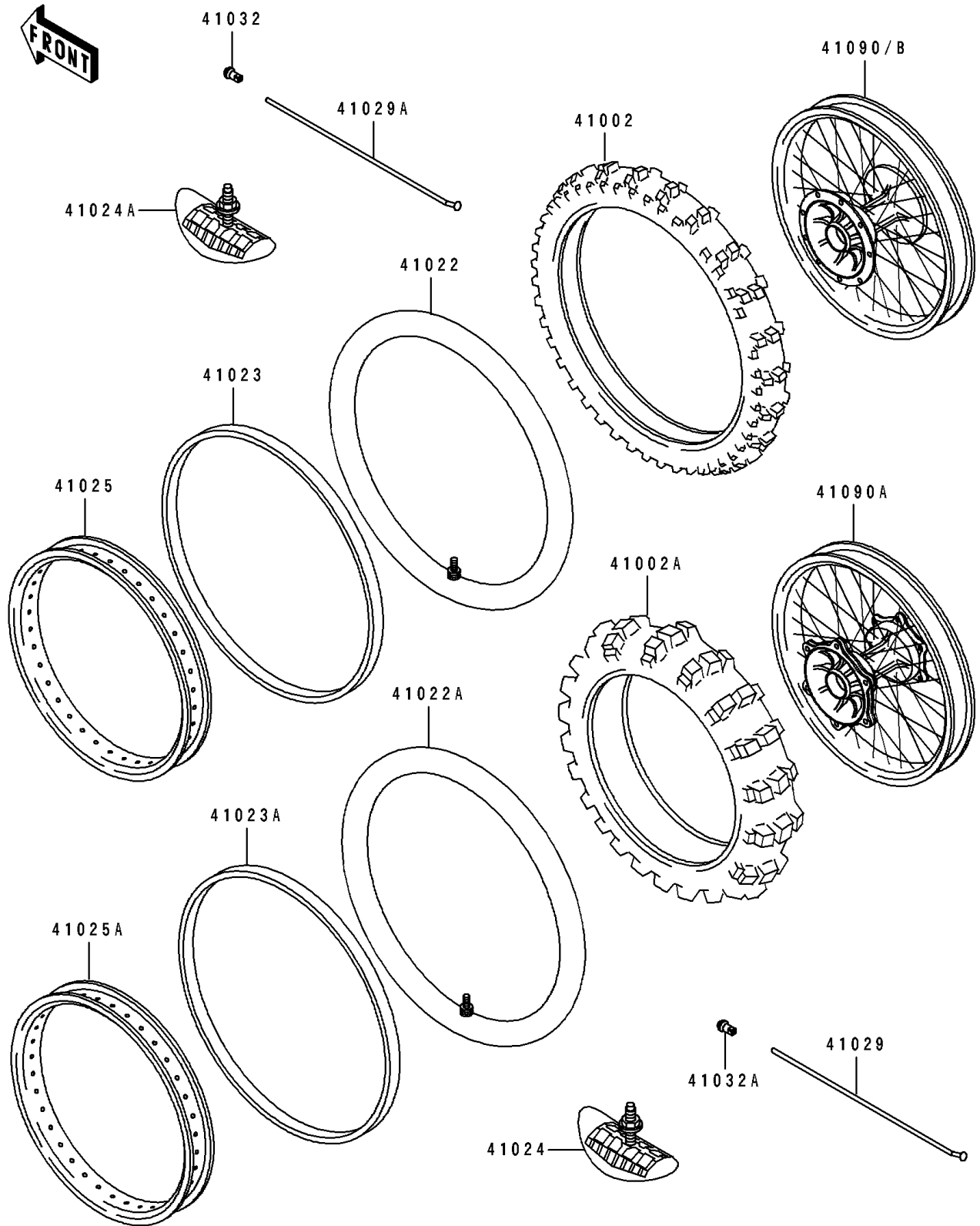

1992 KDX250 PARTS LIST

Wheels/Tires

ITEM NAME	PART NUMBER	QUANTITY
TIRE,FR,80/100-21 51M,D752F(D) (Ref # 41002)	41002-1801	1
TIRE,RR,110/100-18 64M,D752(D) (Ref # 41002A)	41002-1867	1
TUBE-TIRE,80/100-21(D) (Ref # 41022)	41022-1118	1
TUBE-TIRE,RR,110/100-18(D) (Ref # 41022A)	41022-1120	1
BAND-RIM,80/100-21(D) (Ref # 41023)	41023-1069	1
BAND-RIM,100/100-18(D) (Ref # 41023A)	41023-1070	1
STOPPER-RIM,2.15-M(DUNLOP) (Ref # 41024)	41024-009	1
STOPPER-RIM,1.60-M(DUNLOP) (Ref # 41024A)	41024-010	1
RIM,FR,1.60X21 (Ref # 41025)	41025-1257	1
RIM,RR,2.15X18 (Ref # 41025A)	41025-1258	1
SPOKE-INNER,RR,190MMX160D (Ref # 41029)	41029-1198	36
SPOKE-INNER,FR,228MMX165D (Ref # 41029A)	41029-1206	36
NIPPLE-SPOKE (Ref # 41032)	41032-1061	36
NIPPLE-SPOKE (Ref # 41032A)	41032-1064	36
WHEEL-SUB ASSY,RR (Ref # 41090A)	41090-1085	1
WHEEL-SUB ASSY,FR (Ref # 41090B)	41090-1090	1