

# 1987 KDX80 PARTS DIAGRAM

Cylinder Head/Cylinder

E1111-0099

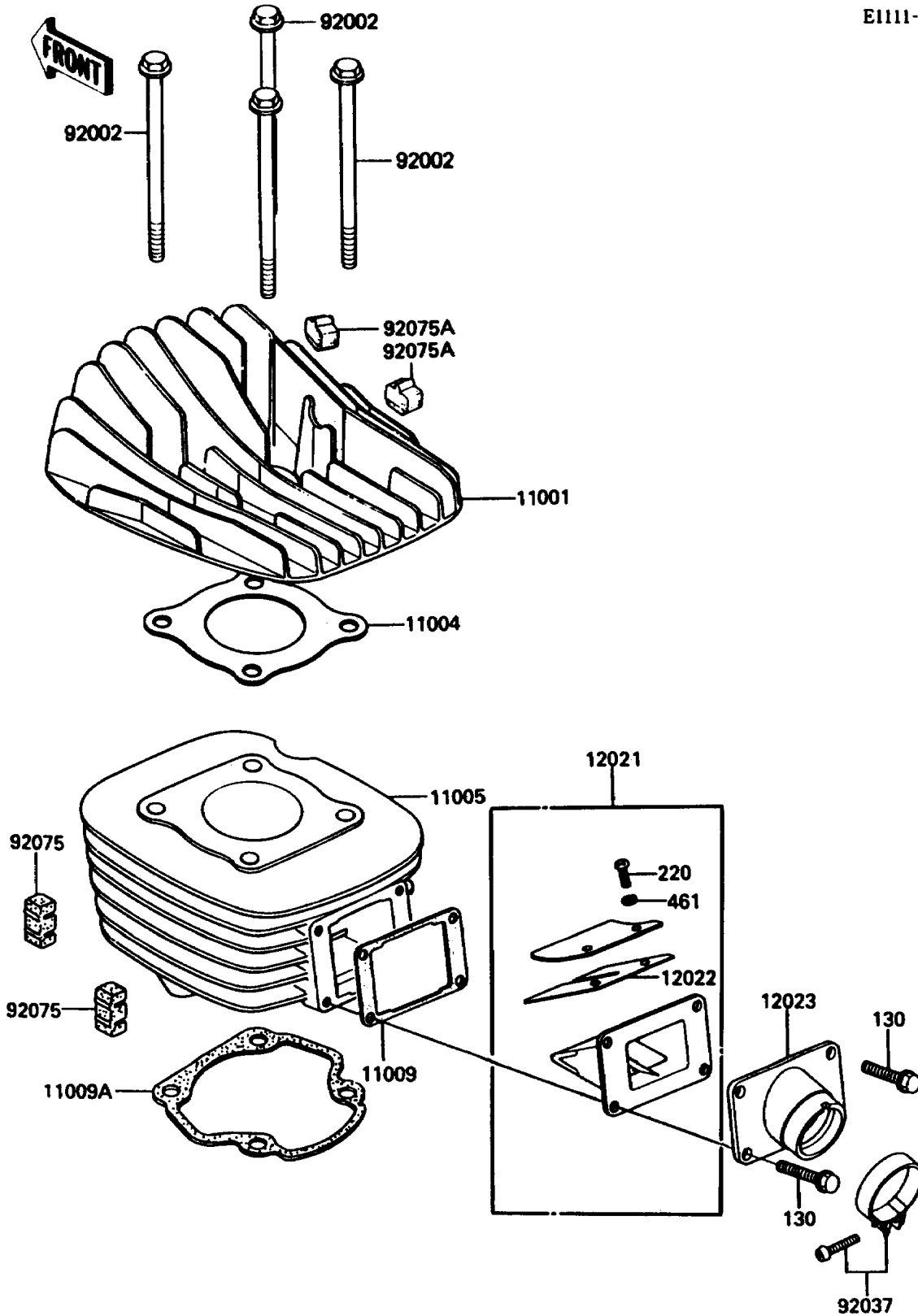

## 1987 KDX80 PARTS LIST

### Cylinder Head/Cylinder

ITEM NAME	PART NUMBER	QUANTITY
HEAD-CYLINDER (Ref # 11001)	11001-1242	1
GASKET-HEAD,CYLINDER (Ref # 11004)	11004-1031	1
CYLINDER-ENGINE,ELECTRO-FUSE (Ref # 11005)	11005-1229	1
GASKET,REED VALVE (Ref # 11009)	11009-1109	1
GASKET,CYLINDER BASE (Ref # 11009A)	11009-1310	1
VALVE-ASSY-REED (Ref # 12021)	12021-1020	1
VALVE-REED (Ref # 12022)	12022-1011	2
HOLDER-VALVE (Ref # 12023)	12023-1014	1
BOLT,8X120 (Ref # 92002)	92002-1332	4
CLAMP (Ref # 92037)	92037-1305	1
DAMPER,CYLINDER (Ref # 92075)	92075-1229	4
DAMPER (Ref # 92075A)	92075-304	4
BOLT-FLANGED,6X20 (Ref # 130)	130G0620	4
SCREW-PAN-CROS (Ref # 220)	220B0308	4
WASHER-SPRING,3MM (Ref # 461)	461F0300	4