

1986 KDX80 PARTS DIAGRAM

Transmission

E1361-0127

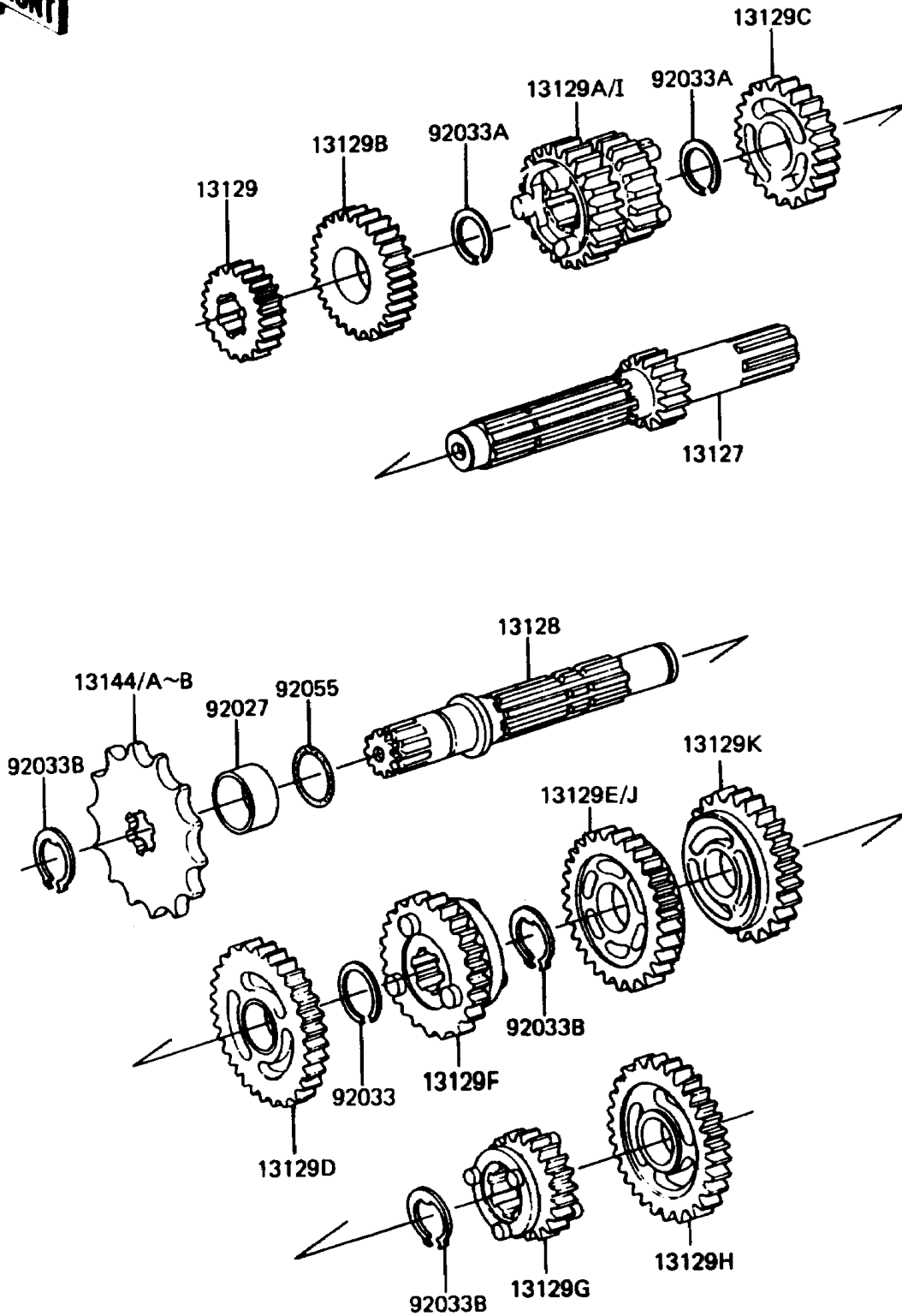

1986 KDX80 PARTS LIST

Transmission

ITEM NAME	PART NUMBER	QUANTITY
SHAFT-TRANSMISSION INPUT,13T (Ref # 13127)	13127-1105	1
SHAFT-TRANSMISSION OUTPUT (Ref # 13128)	13128-1028	1
GEAR,INPUT 2ND,16T (Ref # 13129)	13129-1215	1
GEAR,INPUT 5TH,23T (Ref # 13129B)	13129-1343	1
GEAR,INPUT TOP,24T (Ref # 13129C)	13129-1344	1
GEAR,OUTPUT 2ND,34T (Ref # 13129D)	13129-1345	1
GEAR,OUTPUT 5TH,28T (Ref # 13129F)	13129-1348	1
GEAR,OUTPUT TOP,26T (Ref # 13129G)	13129-1349	1
GEAR,OUTPUT LOW,37T (Ref # 13129H)	13129-1515	1
GEAR,INPUT 3RD&4TH,21T&18T (Ref # 13129I)	13129-1611	1
GEAR,OUTPUT 4TH,30T (Ref # 13129J)	13129-1612	1
GEAR,OUTPUT 3RD,31T (Ref # 13129K)	13129-1654	1
SPROCKET-OUTPUT,14T (Ref # 13144)	13144-1022	1
SPROCKET-OUTPUT,13T (Ref # 13144A)	13144-1023	1
SPROCKET-OUTPUT,15T (Ref # 13144B)	13144-1024	1
COLLAR,20X25X12.5 (Ref # 92027)	92027-1077	1
RING-SNAP,18MM (Ref # 92033)	92033-029	1
RING-SNAP,17MM (Ref # 92033A)	92033-1060	2
RING-SNAP,18MM (Ref # 92033B)	92033-1079	3
RING-O,17.5X1.5 (Ref # 92055)	92055-022	1