

1987 KDX80 PARTS DIAGRAM

Front Fork

F2340-0212

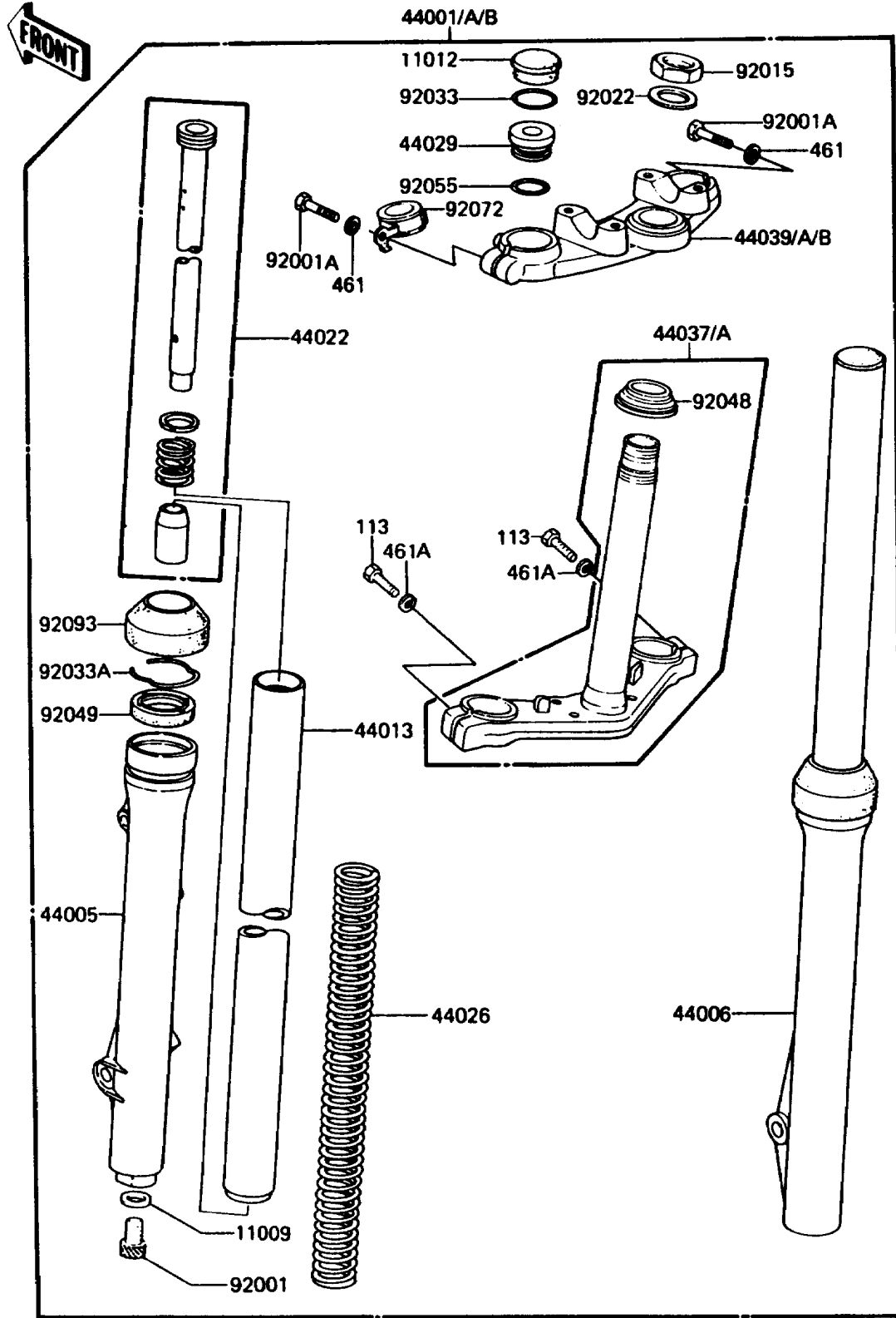

1987 KDX80 PARTS LIST

Front Fork

ITEM NAME	PART NUMBER	QUANTITY
GASKET,FORK CYLINDER BOLT (Ref # 11009)	44045-051	2
CAP,RUBBER,FORK TOP (Ref # 11012)	11012-1067	2
FORK-FRONT (Ref # 44001A)	44001-1557	1
PIPE-LEFT FORK OUTER (Ref # 44005)	44005-1101	1
PIPE-RIGHT FORK OUTER (Ref # 44006)	44006-1101	1
PIPE-FORK INNER,D=30 (Ref # 44013)	44013-1061	2
CYLINDER-FORK (Ref # 44022)	44022-1058	2
SPRING-FRONT FORK,L=546.5 (Ref # 44026)	44026-1109	2
SEAT-FORK SPRING (Ref # 44029)	44029-022	2
HOLDER-FORK UNDER (Ref # 44037)	44037-1157	1
HOLDER-FORK UPPER (Ref # 44039A)	44039-1112	1
BOLT,FORK CYLINDER (Ref # 92001)	44041-078	2
BOLT,8X35 (Ref # 92001A)	92001-1643	2
NUT,FORK TOP (Ref # 92015)	92015-1224	1
WASHER,FORK TOP (Ref # 92022)	92022-1385	1
RING-SNAP (Ref # 92033)	44044-023	2
RING-SNAP,FORK OUTER TUBE (Ref # 92033A)	92033-1028	2
RACE,STEERING STEM BEARING (Ref # 92048)	92047-010	1
SEAL-OIL,FORK OUTER TUBE (Ref # 92049)	92049-1069	2
RING-O (Ref # 92055)	44046-025	2
BAND,CABLE (Ref # 92072)	92072-1089	1
DUST SHIELD,FORK (Ref # 92093)	92093-1054	2
BOLT-SMALL-FINE,10X35 (Ref # 113)	113B1035	2
WASHER-SPRING,8MM (Ref # 461)	461F0800	2
WASHER-SPRING,10MM (Ref # 461A)	461F1000	2