

1990 KE100 PARTS DIAGRAM

Crankshaft/Piston

E1321-0021

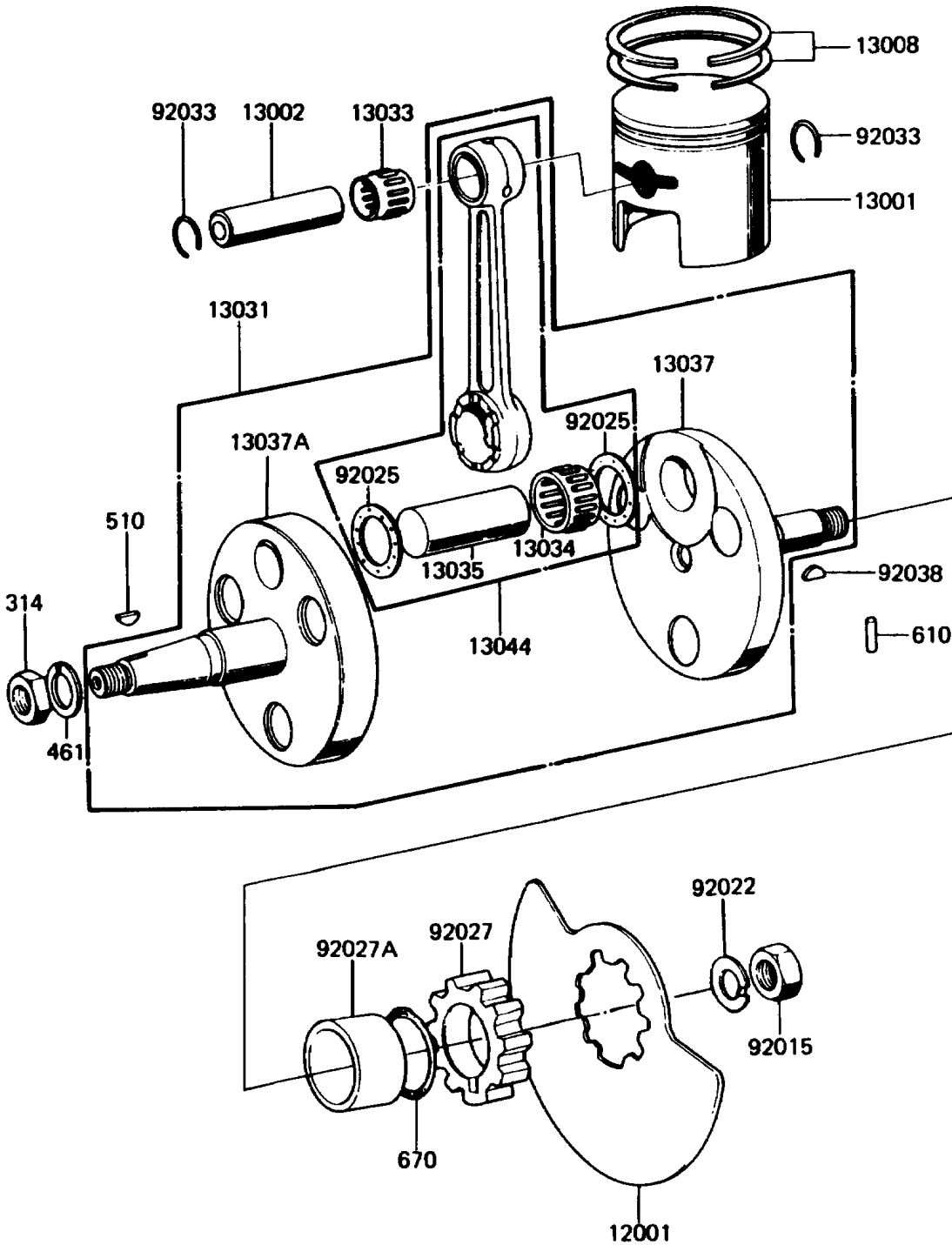

1990 KE100 PARTS LIST

Crankshaft/Piston

| ITEM NAME | PART NUMBER | QUANTITY |
|--|-------------|----------|
| VALVE-ROTARY (Ref # 12001) | 12002-030 | 1 |
| PISTON-ENGINE,STD (Ref # 13001) | 13001-057 | 1 |
| PIN-PISTON (Ref # 13002) | 13002-003 | 1 |
| RING-SET-PISTON,STD (Ref # 13008) | 13008-5009 | 1 |
| CRANKSHAFT-COMP (Ref # 13031) | 13036-043 | 1 |
| BEARING-NEEDLE,KTV141817 (Ref # 13033) | 13033-030 | 1 |
| BEARING-NEEDLE,KT192814 (Ref # 13034) | 13034-034 | 1 |
| PIN-CRANK (Ref # 13035) | 13035-025 | 1 |
| CRANKSHAFT,RH (Ref # 13037) | 13037-1135 | 1 |
| CRANKSHAFT,LH (Ref # 13037A) | 13037-1136 | 1 |
| SET-CONNECTING ROD (Ref # 13044) | 13044-5015 | 1 |
| NUT,12MM (Ref # 92015) | 92015-006 | 1 |
| WASHER,CLAW,12.5X25X0.8 (Ref # 92022) | 92024-003 | 1 |
| SHIM,T=1.0 (Ref # 92025) | 92025-047 | 2 |
| COLLAR,ROTARY VALVE (Ref # 92027) | 92027-1245 | 1 |
| COLLAR,20X25X9.5 (Ref # 92027A) | 92027-285 | 1 |
| RING-SNAP,PISTON PIN (Ref # 92033) | 92036-003 | 2 |
| KEY,WOODRUFF (Ref # 92038) | 92038-003 | 1 |
| NUT-HEX-FINE,10MM (Ref # 314) | 314B1000 | 1 |
| WASHER-SPRING,10MM (Ref # 461) | 461E1000 | 1 |
| KEY-WOODRUFF (Ref # 510) | 510A3200 | 1 |
| ROLLER,4X10 (Ref # 610) | 610A0410 | 1 |
| O RING,16MM (Ref # 670) | 670B2016 | 1 |