

1990 KE100 PARTS DIAGRAM

Change Drum/Shift Fork

E1362-0008

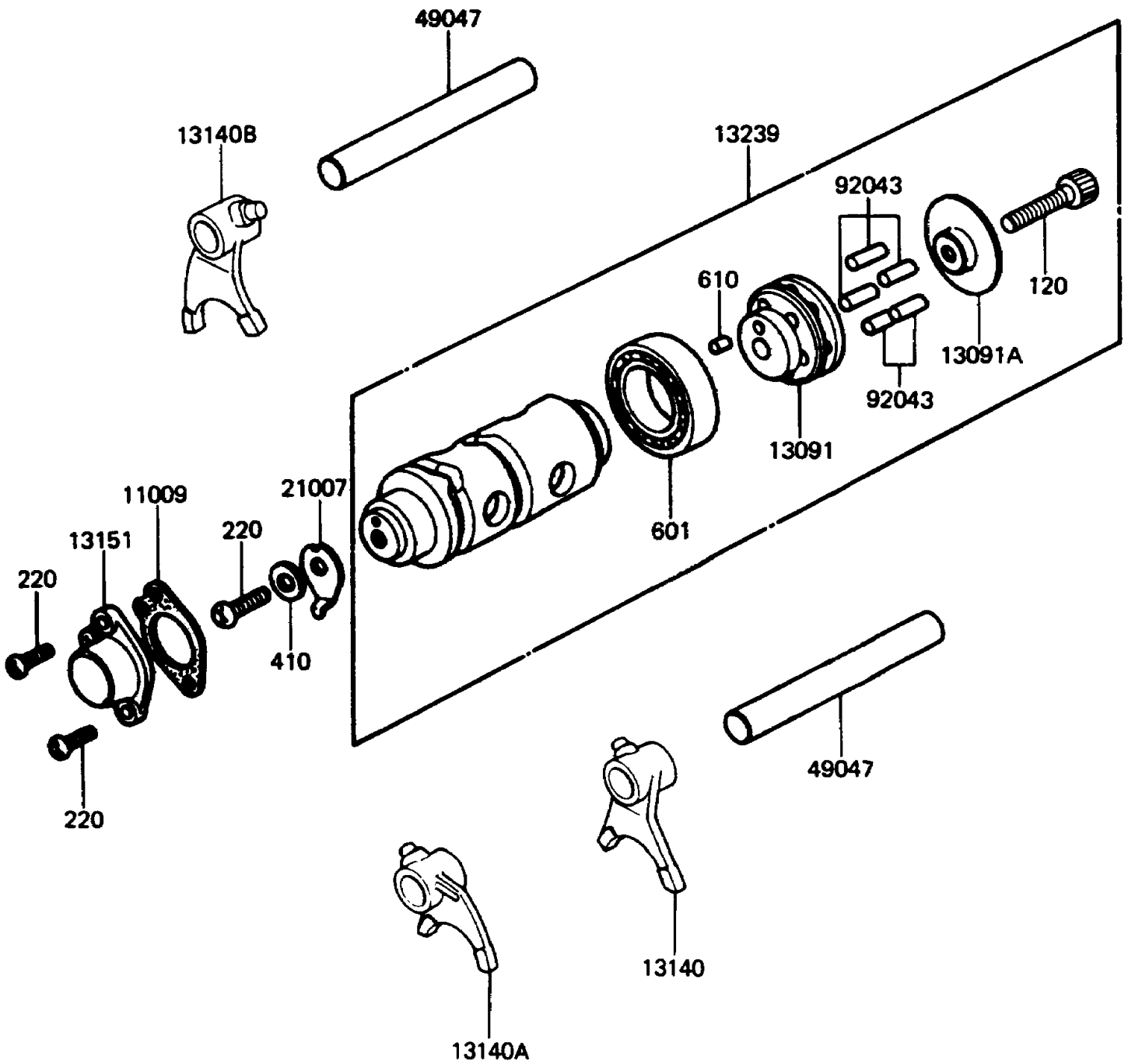

1990 KE100 PARTS LIST

Change Drum/Shift Fork

ITEM NAME	PART NUMBER	QUANTITY
GASKET,NEUTRAL SWITCH (Ref # 11009)	13146-002	1
HOLDER,CHANGE DRUM (Ref # 13091)	13091-1077	1
HOLDER,CHANGE DRUM PIN (Ref # 13091A)	13142-014	1
FORK-SHIFT,LOW&2ND (Ref # 13140)	13140-1026	1
FORK-SHIFT,3RD (Ref # 13140A)	13140-1027	1
FORK-SHIFT,4TH&TOP (Ref # 13140B)	13140-1028	1
SWITCH-COMP,NEUTRAL (Ref # 13151)	13151-1002	1
DRUM-ASSY-CHANGE (Ref # 13239)	13239-1034	1
ROTOR,TOP & NEUTRAL (Ref # 21007)	21007-1003	1
ROD-SHIFT,10X80 (Ref # 49047)	13209-014	2
PIN,DOWEL,4X14.8 (Ref # 92043)	92042-042	5
BOLT-SOCKET,6X30 (Ref # 120)	120Q0630	1
SCREW-PAN-CROS,6X16 (Ref # 220)	220B0616	3
WASHER-PLAIN-SMALL,6MM (Ref # 410)	410B0600	1
BEARING-BALL,#6004C3 (Ref # 601)	601B6004	1
ROLLER,4X6 (Ref # 610)	610A0406	1