

1988 KE100 PARTS DIAGRAM

Frame Fitting

F2131-0066

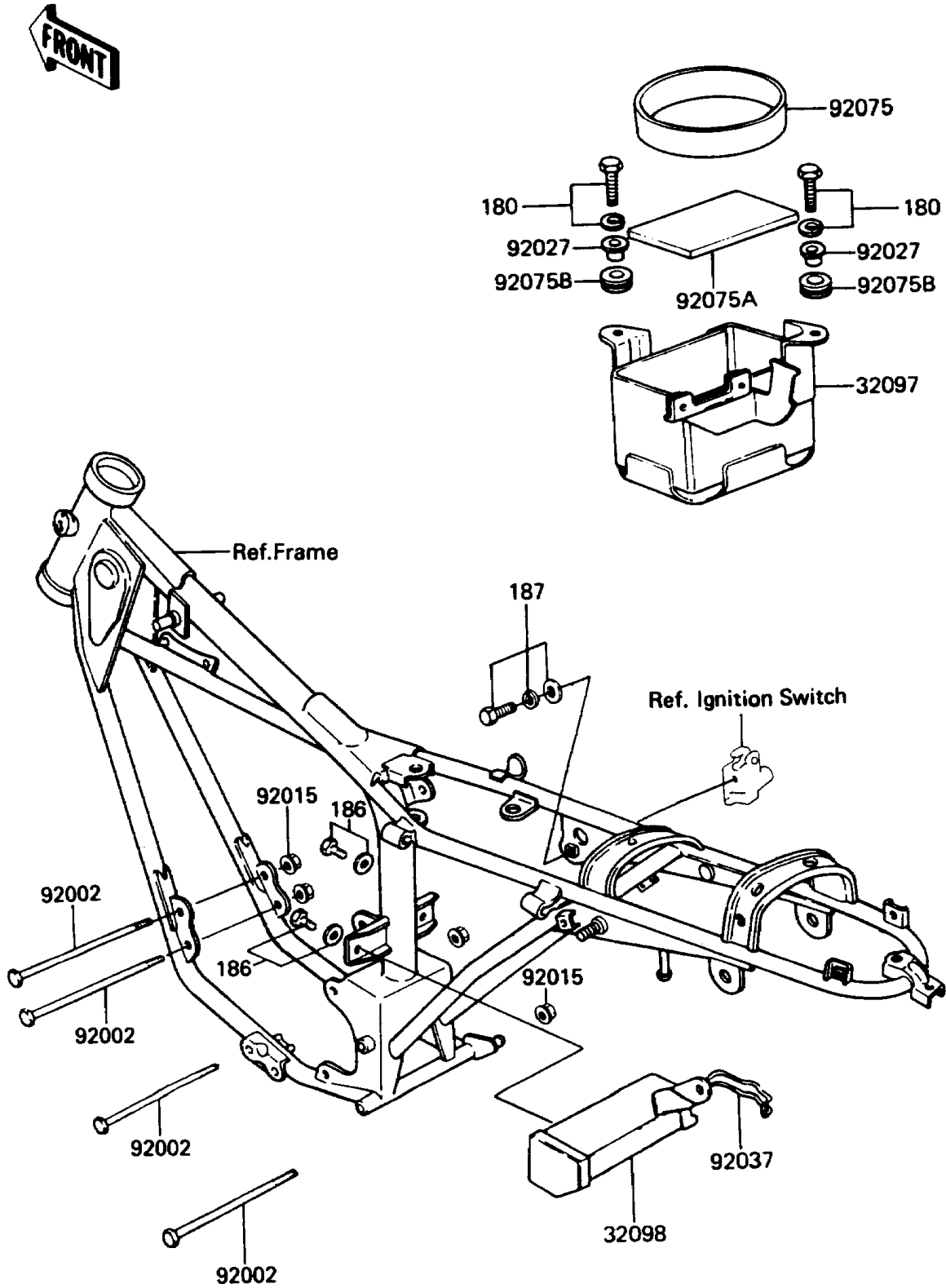

1988 KE100 PARTS LIST

Frame Fitting

ITEM NAME	PART NUMBER	QUANTITY
CASE-BATTERY (Ref # 32097)	32097-1009	1
CASE-TOOL (Ref # 32098)	32098-018	1
BOLT,10X115 (Ref # 92002)	92002-1072	4
NUT,FLANGED,10MM (Ref # 92015)	92015-1180	4
COLLAR,L=7 (Ref # 92027)	92027-153	2
CLAMP,TOOL CASE (Ref # 92037)	92079-002	1
DAMPER,BATTERY BOTTOM (Ref # 92075)	32103-023	1
DAMPER,BATTERY (Ref # 92075A)	32103-027	1
DAMPER (Ref # 92075B)	92075-051	2
BOLT-UPSET-WS (Ref # 180)	180B0618	2
BOLT-UPSET-WP (Ref # 186)	186B0614	2
BOLT-UPSET-WSP (Ref # 187)	187B0612	1