

1990 KE100 PARTS DIAGRAM

Turn Signal

F2730-0058

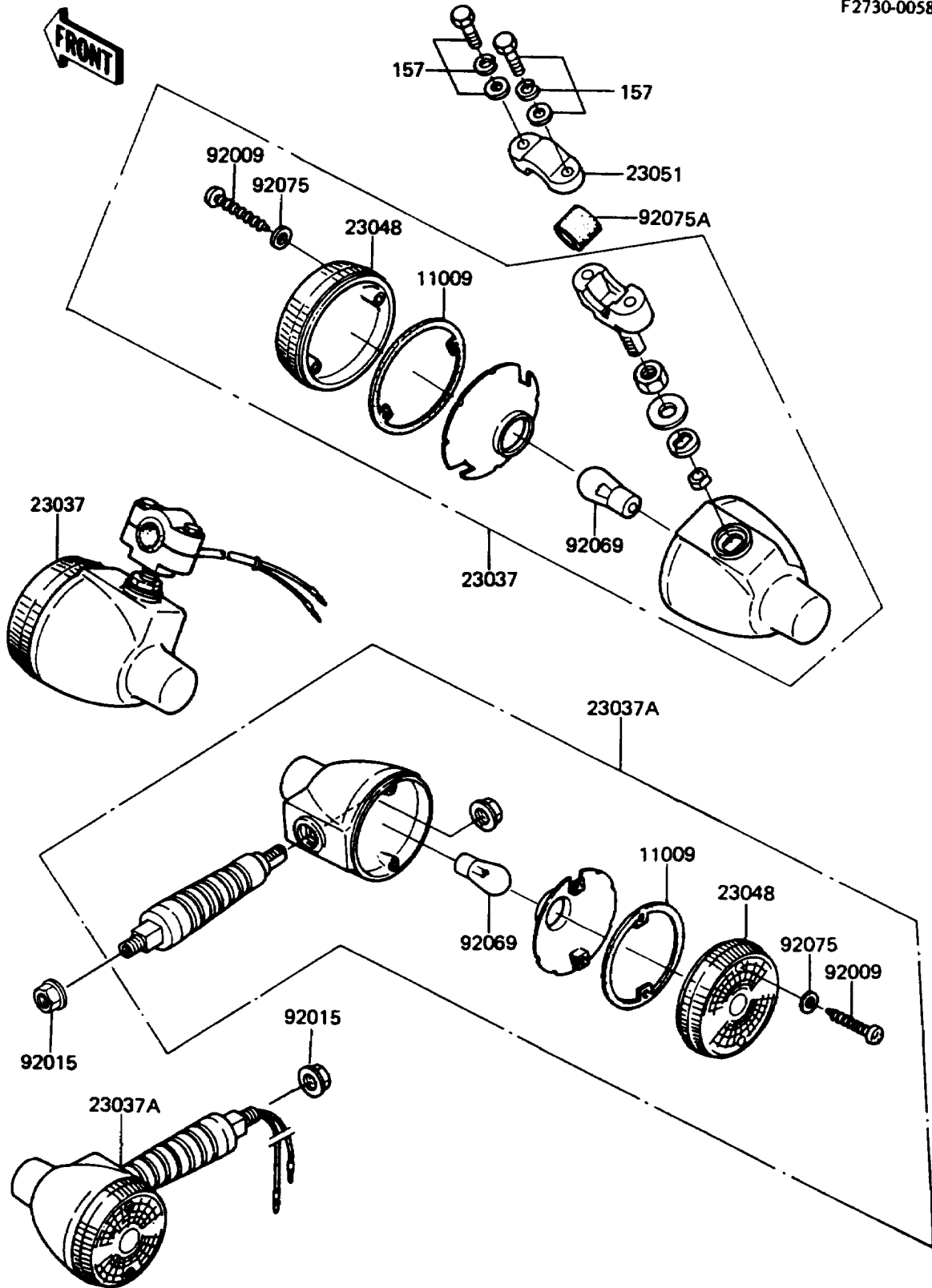

1990 KE100 PARTS LIST

Turn Signal

ITEM NAME	PART NUMBER	QUANTITY
GASKET,TURN SIGNAL LAMP LENS (Ref # 11009)	11009-1128	4
LAMP-ASSY-SIGNAL,FR (Ref # 23037)	23037-1039	2
LAMP-ASSY-SIGNAL,RR (Ref # 23037A)	23037-1087	2
LENS-SIGNAL LAMP (Ref # 23048)	23048-1076	4
BRACKET-SIGNAL LAMP (Ref # 23051)	23051-1018	2
SCREW,TAPPING,4X30 (Ref # 92009)	92009-1056	8
NUT,FLANGED,10MM (Ref # 92015)	92015-1428	2
BULB,6V 21CP (Ref # 92069)	92069-056	4
WASHER,PLAIN,4MM (Ref # 92075)	23058-002	8
DAMPER (Ref # 92075A)	23066-003	2
BOLT-WSP (Ref # 157)	157B0530	4