

1996 KE100 PARTS DIAGRAM

Gear Change Mechanism

E1370

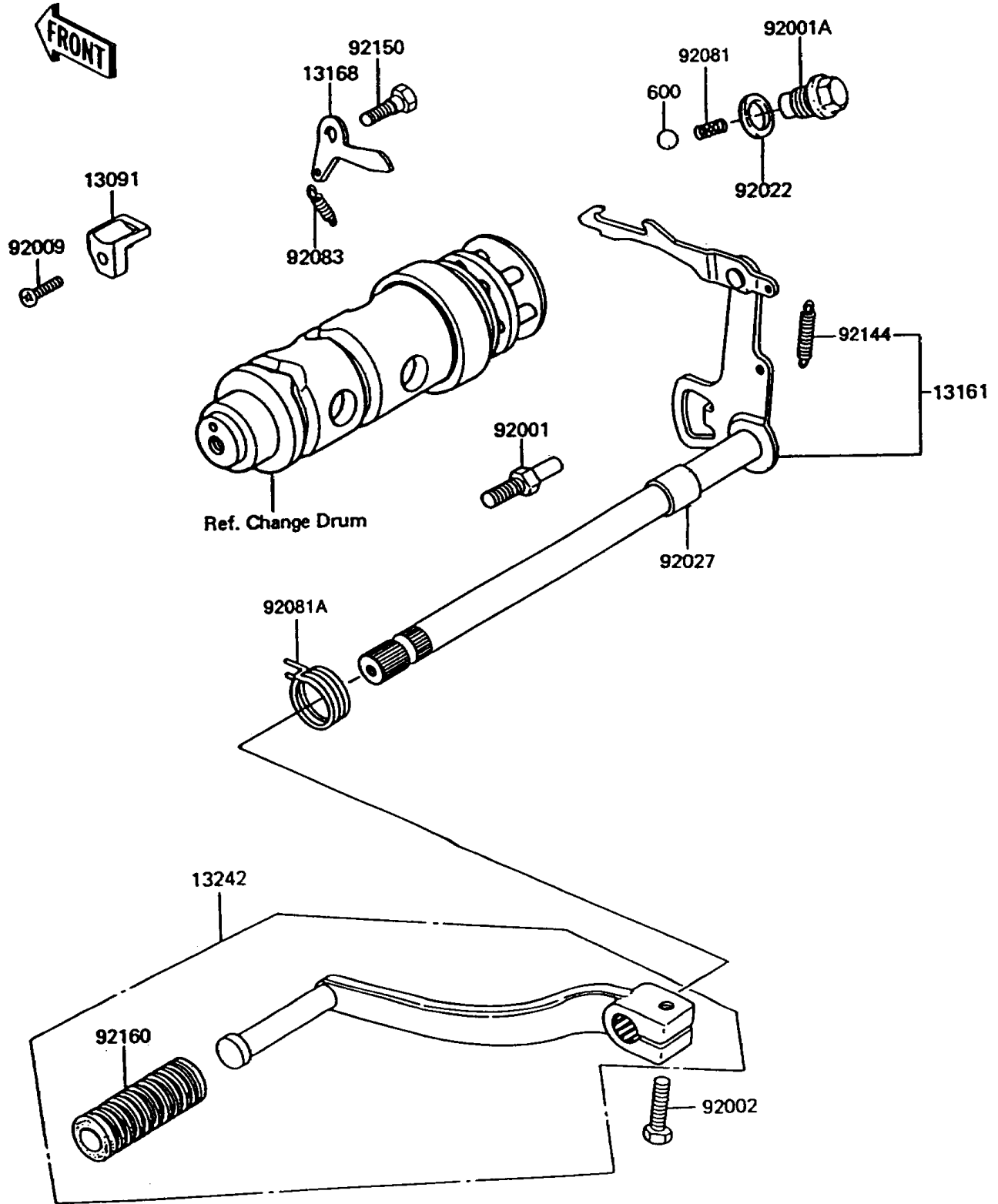

1996 KE100 PARTS LIST

Gear Change Mechanism

ITEM NAME	PART NUMBER	QUANTITY
BALL-STEEL,13/32" (Ref # 600)	600A1300	1
HOLDER (Ref # 13091)	13091-1350	1
LEVER-COMP-CHANGE SHAFT (Ref # 13161)	13161-1197	1
LEVER,GEAR CHANGE DRUM (Ref # 13168)	13168-1046	1
LEVER-ASSY-CHANGE (Ref # 13242)	13242-004	1
BOLT,RETURN SPRING (Ref # 92001)	92001-1455	1
BOLT,16X28.5 (Ref # 92001A)	92001-1934	1
BOLT,6X20 (Ref # 92002)	92002-1237	1
SCREW (Ref # 92009)	92009-1266	1
WASHER,16.5X23X2 (Ref # 92022)	92022-324	1
COLLAR,12X18X11.5 (Ref # 92027)	92027-121	1
SPRING (Ref # 92081)	92081-112	1
SPRING,TENSION (Ref # 92081A)	92081-1129	1
SPRING,CHANGE DRUM LEVER (Ref # 92083)	92083-012	1
SPRING,CHANGE LEVER (Ref # 92144)	92144-1720	1
BOLT,CHANGE DRUM LEVER (Ref # 92150)	92150-1450	1
DAMPER,CHANGE PEDAL (Ref # 92160)	92160-1036	1