

1996 KE100 PARTS DIAGRAM

Frame Fittings

F2131

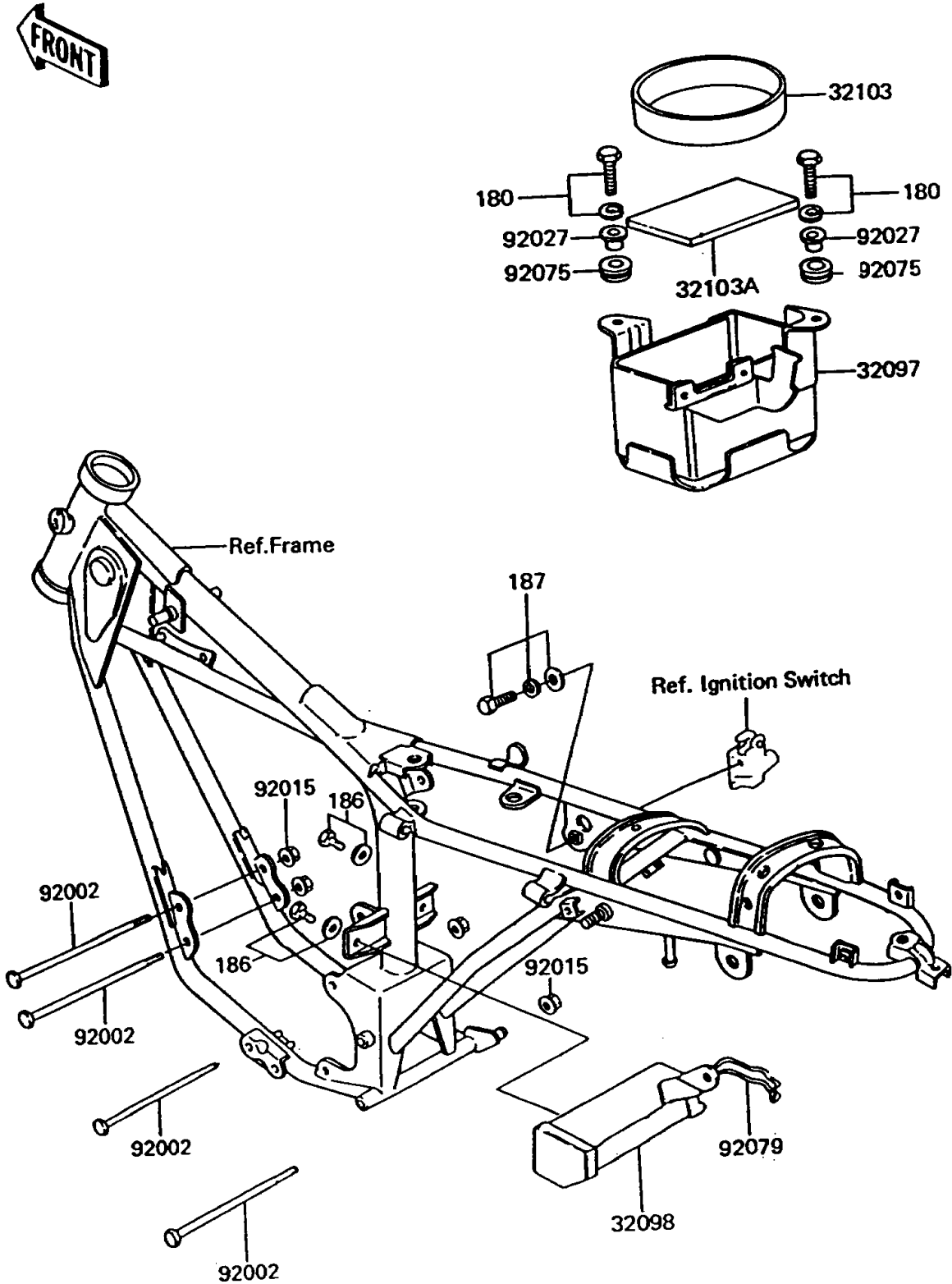

1996 KE100 PARTS LIST

Frame Fittings

ITEM NAME	PART NUMBER	QUANTITY
BOLT-UPSET-WS (Ref # 180)	180B0618	2
BOLT-UPSET-WP (Ref # 186)	186B0614	2
BOLT-UPSET-WSP (Ref # 187)	187B0612	1
CASE-BATTERY (Ref # 32097)	32097-1009	1
CASE-TOOL (Ref # 32098)	32098-018	1
DAMPER,BATTERY BOTTOM (Ref # 32103)	32103-023	1
DAMPER,BATTERY (Ref # 32103A)	32103-027	1
BOLT,10X115 (Ref # 92002)	92002-1072	4
NUT,FLANGED,10MM (Ref # 92015)	92015-1180	4
COLLAR,L=7 (Ref # 92027)	92027-153	2
DAMPER (Ref # 92075)	92075-051	2
CLAMP,TOOL CASE (Ref # 92079)	92079-002	1