

1993 KE100 PARTS DIAGRAM

Meter(s)

F2530

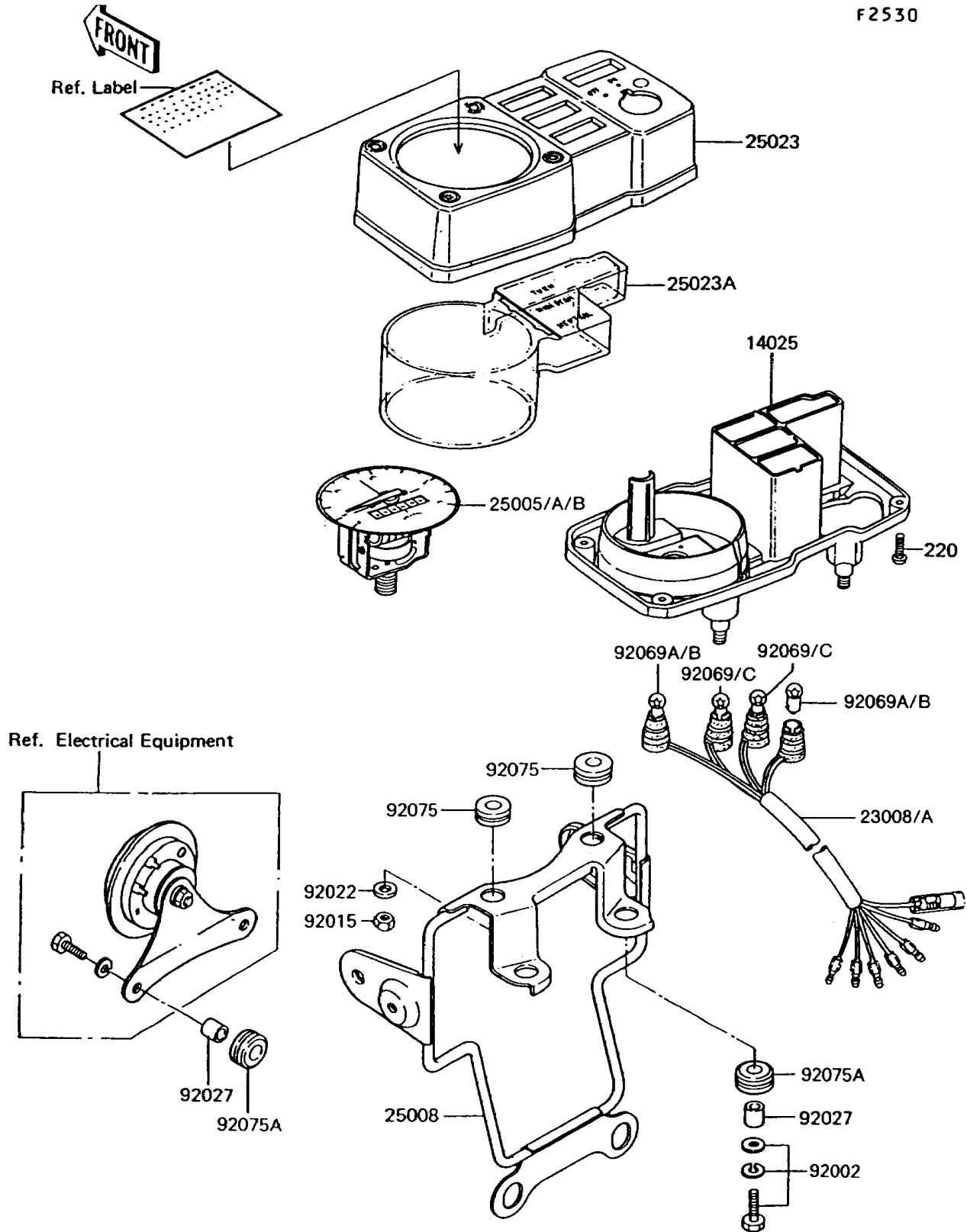

1993 KE100 PARTS LIST

Meter(s)

ITEM NAME	PART NUMBER	QUANTITY
SCREW-PAN-CROS (Ref # 220)	220B0410	4
COVER,METER,LWR (Ref # 14025)	14025-1870	1
SOCKET-ASSY,METER (Ref # 23008A)	23008-1523	1
SPEEDOMETER,MPH (Ref # 25005)	25005-1134	1
SPEEDOMETER,KPH (Ref # 25005B)	25005-1136	1
BRACKET-METER (Ref # 25008)	25008-1042	1
COVER-METER CASE,UPP (Ref # 25023)	25023-1035	1
COVER-METER CASE,LWR (Ref # 25023A)	25023-1036	1
BOLT,6X25 (Ref # 92002)	92002-1137	2
NUT,6MM (Ref # 92015)	92015-1391	2
WASHER,6.5X20X1.6 (Ref # 92022)	92022-1557	2
COLLAR,6.8X10X12 (Ref # 92027)	92027-162	4
BULB,6V 3W (Ref # 92069B)	92069-1053	2
BULB,6V 1.7W (Ref # 92069C)	92069-1054	2
DAMPER (Ref # 92075)	92075-076	2
DAMPER (Ref # 92075A)	92075-209	4