

1995 KE100 PARTS DIAGRAM

Headlight(s)

F2710

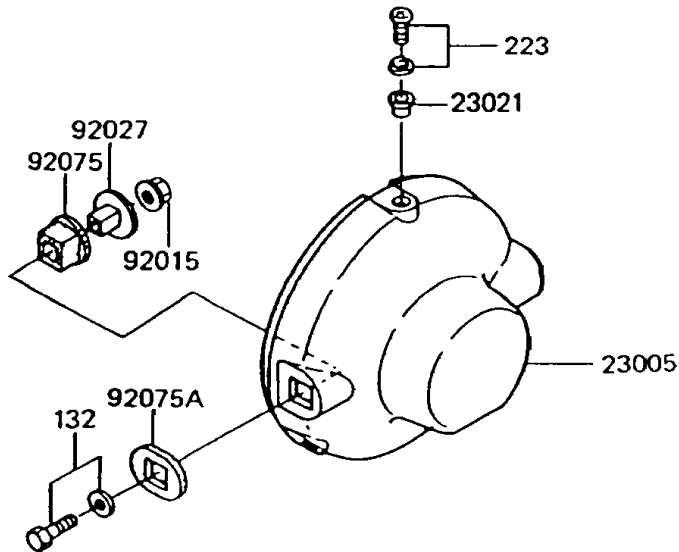
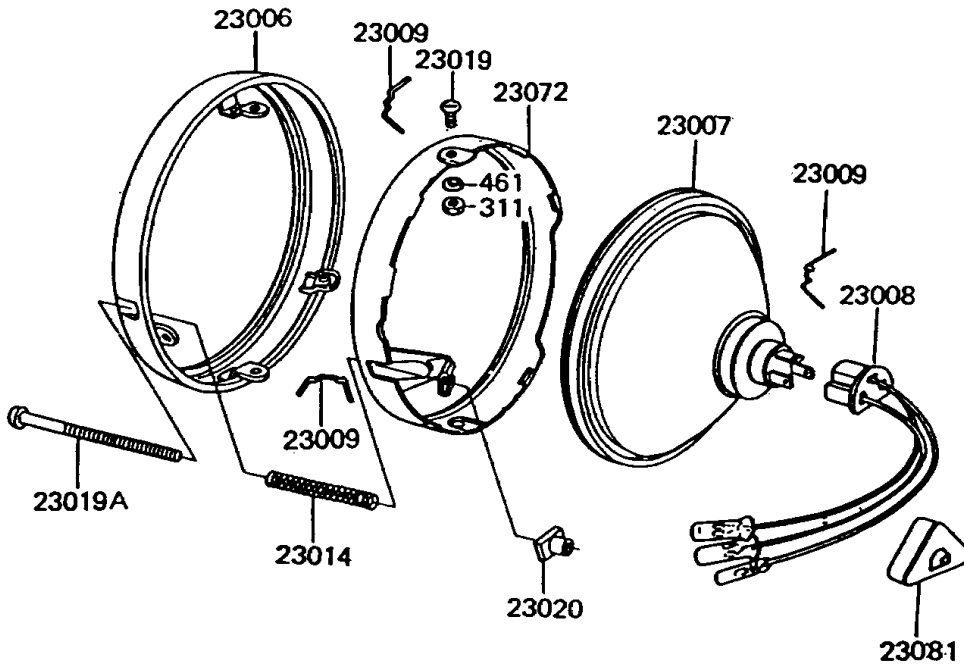

1995 KE100 PARTS LIST

Headlight(s)

ITEM NAME	PART NUMBER	QUANTITY
BOLT-FLANGED-SMALL (Ref # 132)	132E0830	2
SCREW-PAN-WS-CROS (Ref # 223)	223B0512	3
NUT-HEX (Ref # 311)	311B0400	2
WASHER-SPRING,5MM (Ref # 461)	461F0500	2
BODY-COMP-HEAD LAMP,BLACK (Ref # 23005)	23005-1007-6Z	1
RIM-LAMP (Ref # 23006)	23006-1004	1
LENS-COMP,"4020" MARK (Ref # 23007)	23007-055	1
SOCKET-ASSY,HEAD LAMP (Ref # 23008)	23008-044	1
SPRING,HEAD LAMP LENS (Ref # 23009)	23009-015	3
SPRING,FOCUS ADJUSTING (Ref # 23014)	23014-012	1
SCREW,LENS FITTING (Ref # 23019)	23019-026	2
SCREW,FOCUS ADJUSTING (Ref # 23019A)	23019-027	1
NUT,ADJUSTING (Ref # 23020)	23020-012	1
WASHER (Ref # 23021)	23021-010	3
RETAINER,SEALED BEAM (Ref # 23072)	23072-002	1
COVER,HEAD LAMP SOCKET (Ref # 23081)	23081-001	1
NUT,FLANGED,8MM (Ref # 92015)	92015-1014	2
COLLAR,L=15.6 (Ref # 92027)	92027-1105	2
DAMPER,HEAD LAMP (Ref # 92075)	92075-1077	2
DAMPER,HEAD LAMP (Ref # 92075A)	92075-1078	2