

# 1994 KE100 PARTS DIAGRAM

Ignition Switch

F2770

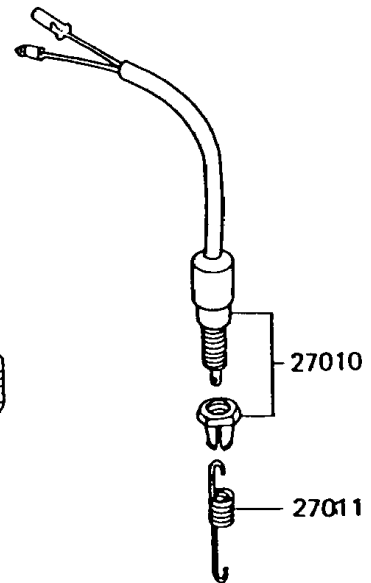
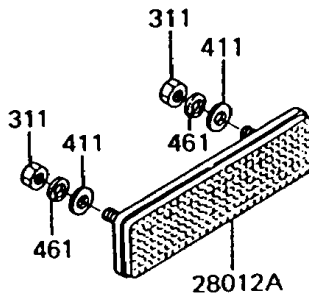
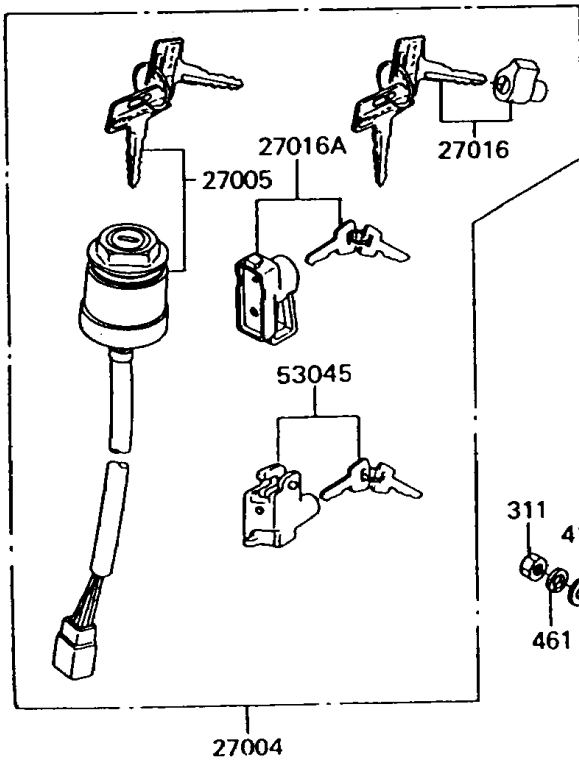
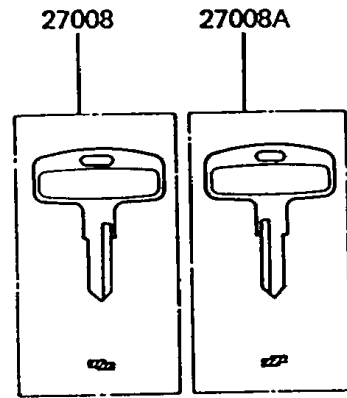
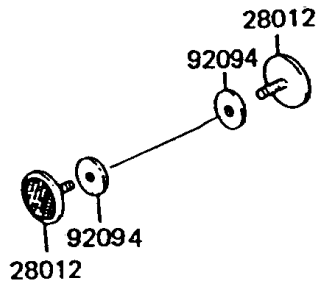
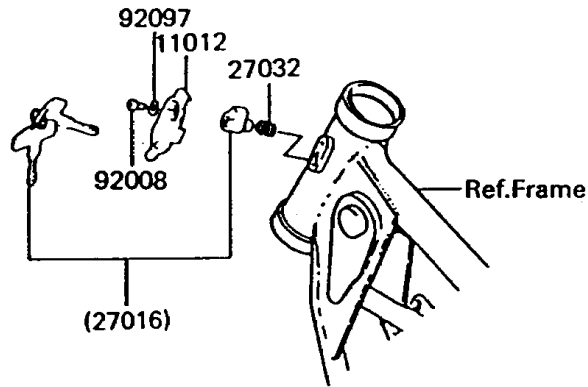

# 1994 KE100 PARTS LIST

## Ignition Switch

ITEM NAME	PART NUMBER	QUANTITY
NUT-HEX (Ref # 311)	311B0500	2
WASHER-PLAIN,5MM (Ref # 411)	411B0500	2
WASHER-SPRING,5MM (Ref # 461)	461F0500	2
CAP,STEERING LOCK (Ref # 11012)	11012-1134	1
SWITCH-ASSY (Ref # 27004)	27004-5276	1
SWITCH-ASSY-IGNITION (Ref # 27005)	27005-1054	1
KEY-LOCK,BLANK (Ref # 27008)	27008-1024	1
KEY-LOCK,BLANK (Ref # 27008A)	27008-1025	1
SWITCH,BRAKE LAMP (Ref # 27010)	27010-025	1
SPRING,BRAKE LAMP SWITCH (Ref # 27011)	27011-011	1
LOCK-ASSY,STEERING (Ref # 27016)	27016-042	1
LOCK-ASSY,HELMET (Ref # 27016A)	27016-5098	1
SPRING,STEERING LOCK (Ref # 27032)	27032-001	1
REFLECTOR-REFLEX,FR (Ref # 28012)	28012-016	2
REFLECTOR-REFLEX,RR (Ref # 28012A)	28012-1005	1
HOOK-ASSY,SEAT (Ref # 53045)	53045-014	1
SCREW,3.51MM (Ref # 92008)	92008-007	1
DAMPER,REFLECTOR (Ref # 92094)	92094-011	2
WASHER,WAVE (Ref # 92097)	92097-003	1