

2000 KE100 PARTS DIAGRAM

Cylinder Head/Cylinder

E1110

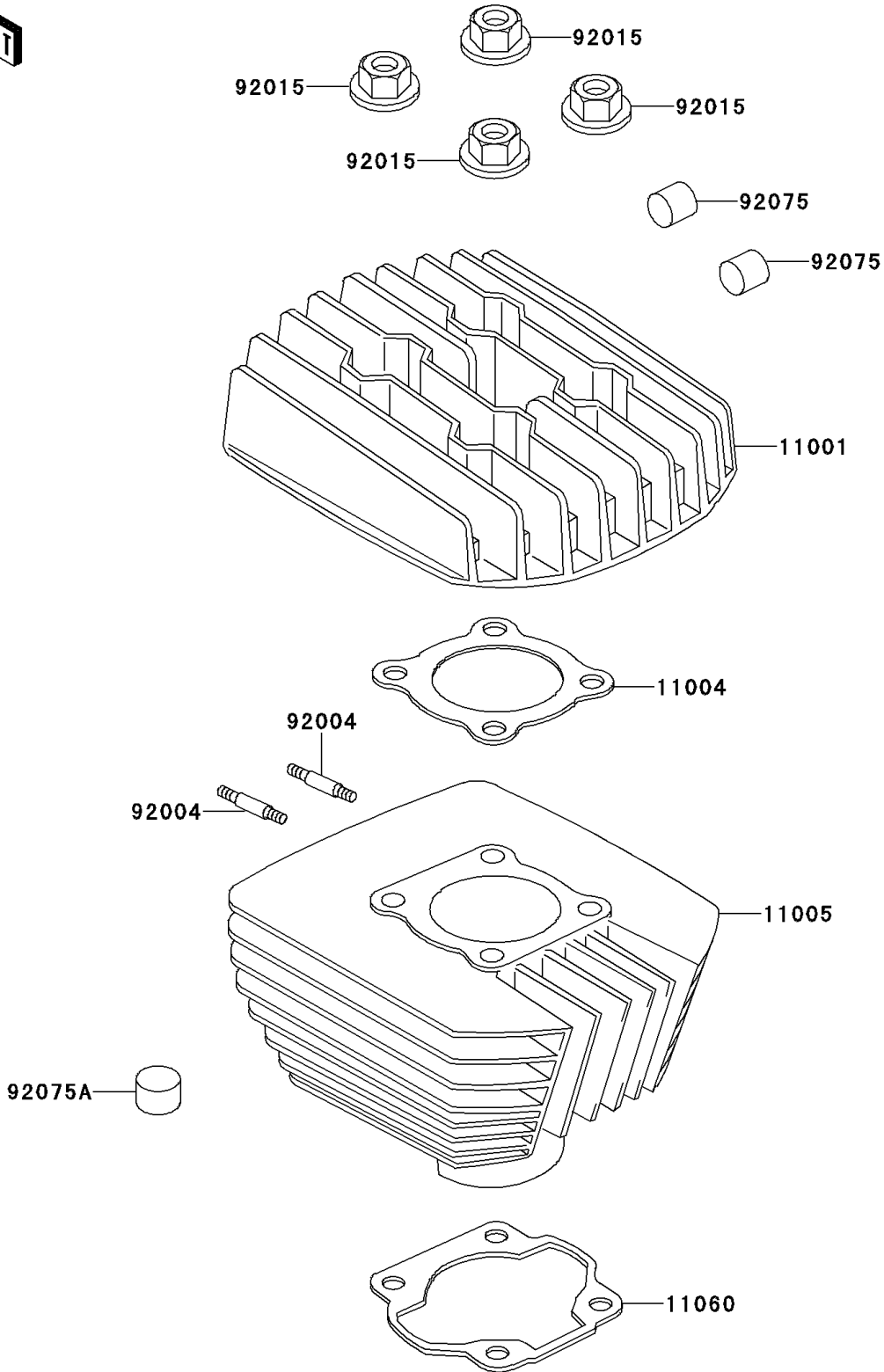

2000 KE100 PARTS LIST

Cylinder Head/Cylinder

ITEM NAME	PART NUMBER	QUANTITY
HEAD-CYLINDER (Ref # 11001)	11001-1018	1
GASKET-HEAD,CYLINDER (Ref # 11004)	11004-033	1
CYLINDER-ENGINE,ELECTRO-FUSE (Ref # 11005)	11005-1006	1
GASKET,CYLINDER BASE (Ref # 11060)	11060-1200	1
STUD,6X22.5 (Ref # 92004)	92004-1119	2
NUT,FLANGED,8MM (Ref # 92015)	92015-1022	4
DAMPER,13X13.8 (Ref # 92075)	92075-075	6
DAMPER,CYLINDER HEAD/CYLINDER (Ref # 92075A)	92075-109	8