

2000 KE100 PARTS DIAGRAM

Transmission

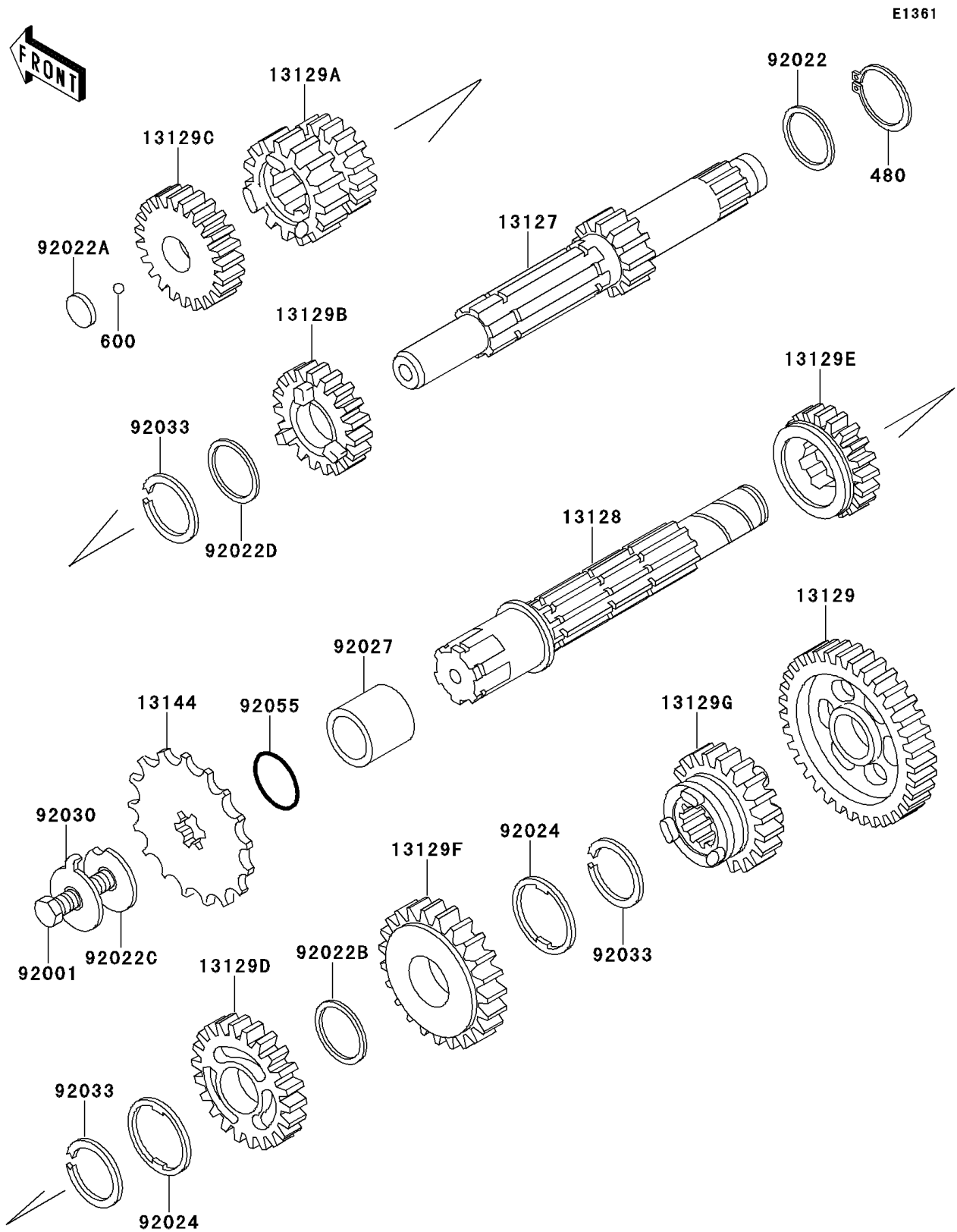

2000 KE100 PARTS LIST

Transmission

ITEM NAME	PART NUMBER	QUANTITY
CIRCLIP-TYPE-C,16MM (Ref # 480)	480J1600	1
BALL-STEEL,7/32" (Ref # 600)	600A0700	1
SHAFT-TRANSMISSION INPUT (Ref # 13127)	13127-1017	1
SHAFT-TRANSMISSION OUTPUT (Ref # 13128)	13128-021	1
GEAR,OUTPUT LOW,35T (Ref # 13129)	13129-010	1
GEAR,INPUT 2ND&3RD,17T&20T (Ref # 13129A)	13129-1138	1
GEAR,INPUT 4TH,22T (Ref # 13129B)	13129-1139	1
GEAR,INPUT TOP,28T (Ref # 13129C)	13129-1146	1
GEAR,OUTPUT 3RD,26T (Ref # 13129D)	13129-1148	1
GEAR,OUTPUT TOP,26T (Ref # 13129E)	13129-1149	1
GEAR,OUTPUT 2ND,30T (Ref # 13129F)	13129-1642	1
GEAR,OUTPUT 4TH,24T (Ref # 13129G)	13129-1708	1
SPROCKET-OUTPUT,15T (Ref # 13144)	13144-054	1
BOLT,8X16 (Ref # 92001)	92001-1368	1
WASHER,THRUST,16.5X21X0.8 (Ref # 92022)	92022-053	1
WASHER,THRUST (Ref # 92022A)	92022-115	1
WASHER,THRUST,18.5X23X1.6 (Ref # 92022B)	92022-146	1
WASHER,T=2.3 (Ref # 92022C)	92022-266	1
WASHER,18.3X22X0.5 (Ref # 92022D)	92022-271	1
WASHER,TOOTHED,18.5X23X1.2 (Ref # 92024)	92024-030	2
COLLAR,ENGINE SPROCKET,L=13.7 (Ref # 92027)	92027-1595	1
WASHER,CLAW,8X22X1.2 (Ref # 92030)	92030-012	1
RING-SNAP,16MM (Ref # 92033)	92033-014	3
RING-O,17.5X1.5 (Ref # 92055)	92055-022	1