

2001 KE100 PARTS DIAGRAM

Ignition System

E1830

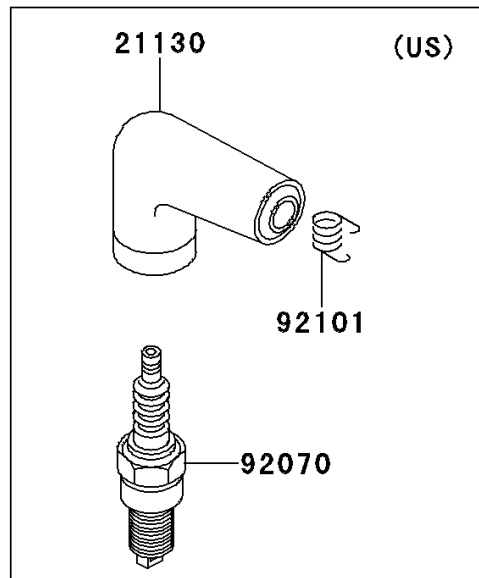
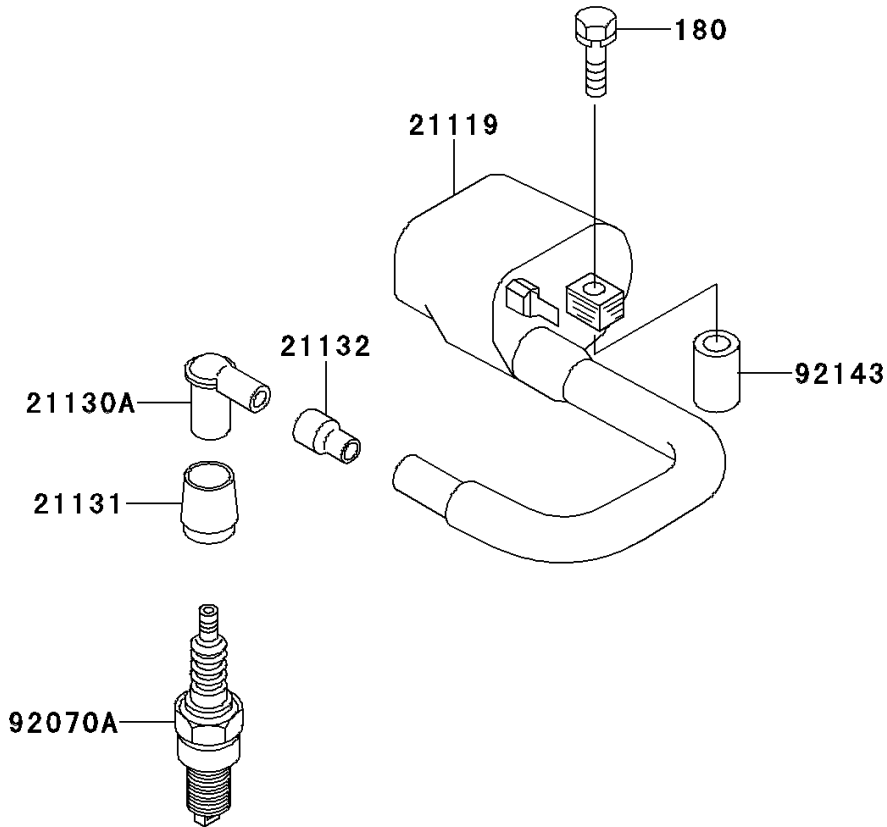

2001 KE100 PARTS LIST

Ignition System

ITEM NAME	PART NUMBER	QUANTITY
BOLT-UPSET-WS (Ref # 180)	180G0645	2
IGNITER (Ref # 21119)	21119-1468	1
CAP-SPARK PLUG (Ref # 21130A)	21130-024	1
GROMMET,PLUG CAP (Ref # 21131)	21131-004	1
GROMMET,HIGH TENSION (Ref # 21132)	21132-005	1
PLUG-SPARK,BR8ES(NGK) (Ref # 92070A)	92070-1021	1
COLLAR (Ref # 92143)	92143-1046	2