

1999 KE100 PARTS DIAGRAM

Frame

F2120

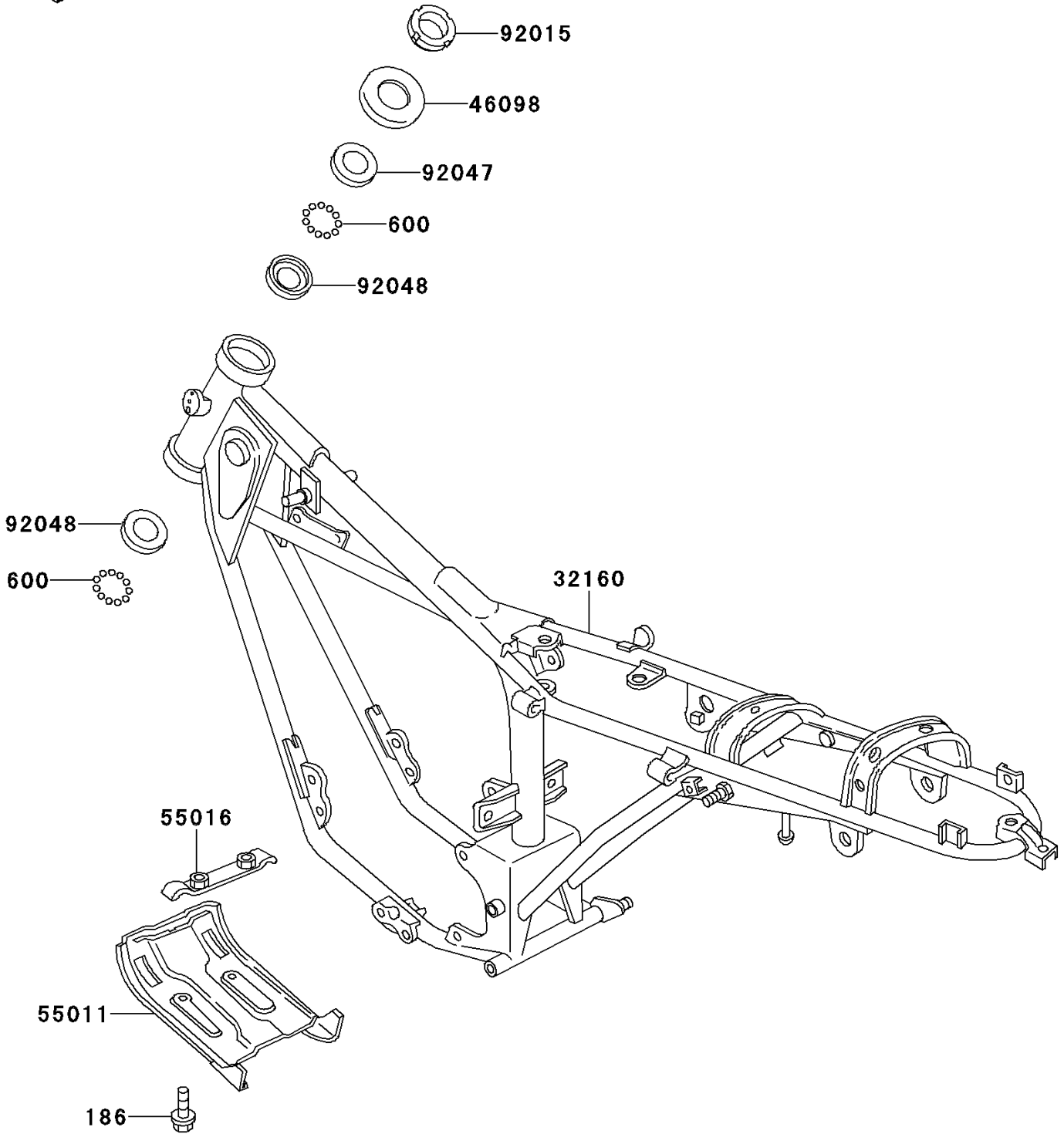

1999 KE100 PARTS LIST

Frame

ITEM NAME	PART NUMBER	QUANTITY
BOLT-UPSET-WP (Ref # 186)	186B0614	2
BALL-STEEL,3/16" (Ref # 600)	600A0600	46
FRAME-COMP (Ref # 32160)	32160-1430	1
CAP,STEERING STEM (Ref # 46098)	46098-004	1
GUARD,ENGINE (Ref # 55011)	55011-018	1
BRACKET,ENGINE GUARD (Ref # 55016)	55016-007	1
NUT,STEERING STEM LOCK,25MM (Ref # 92015)	92015-1382	1
RACE,UPPER BEARING (Ref # 92047)	92047-005	1
RACE,BEARING (Ref # 92048)	92048-004	2