

1997 Lakota 300 PARTS DIAGRAM

Valve(s)

E1210

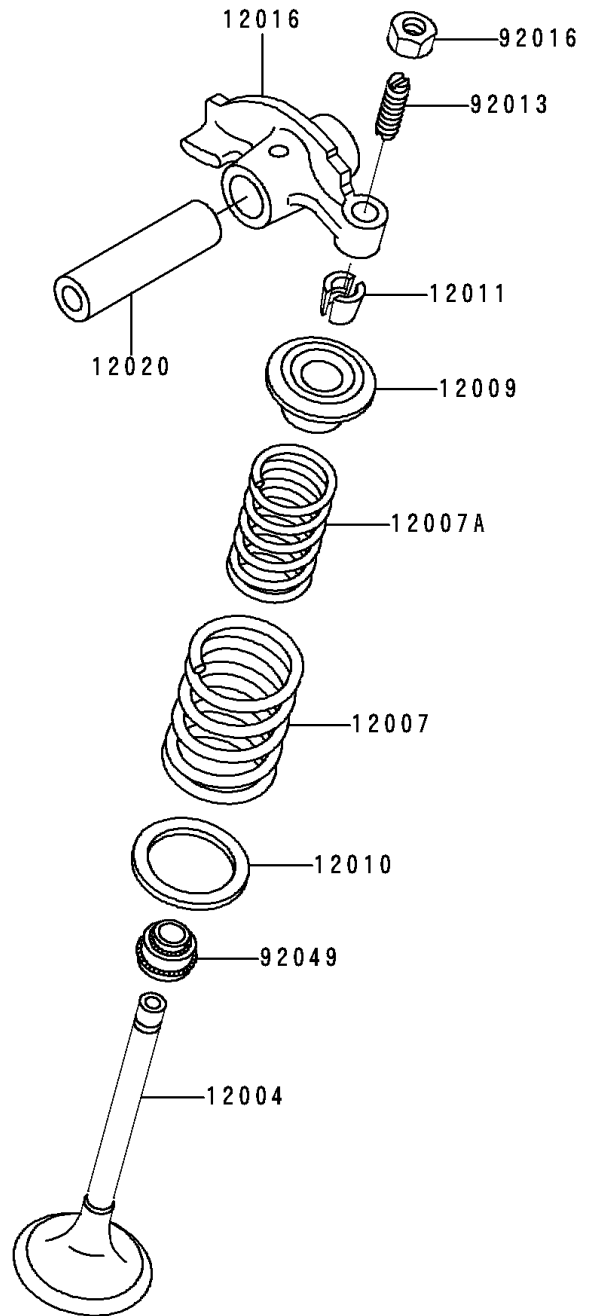
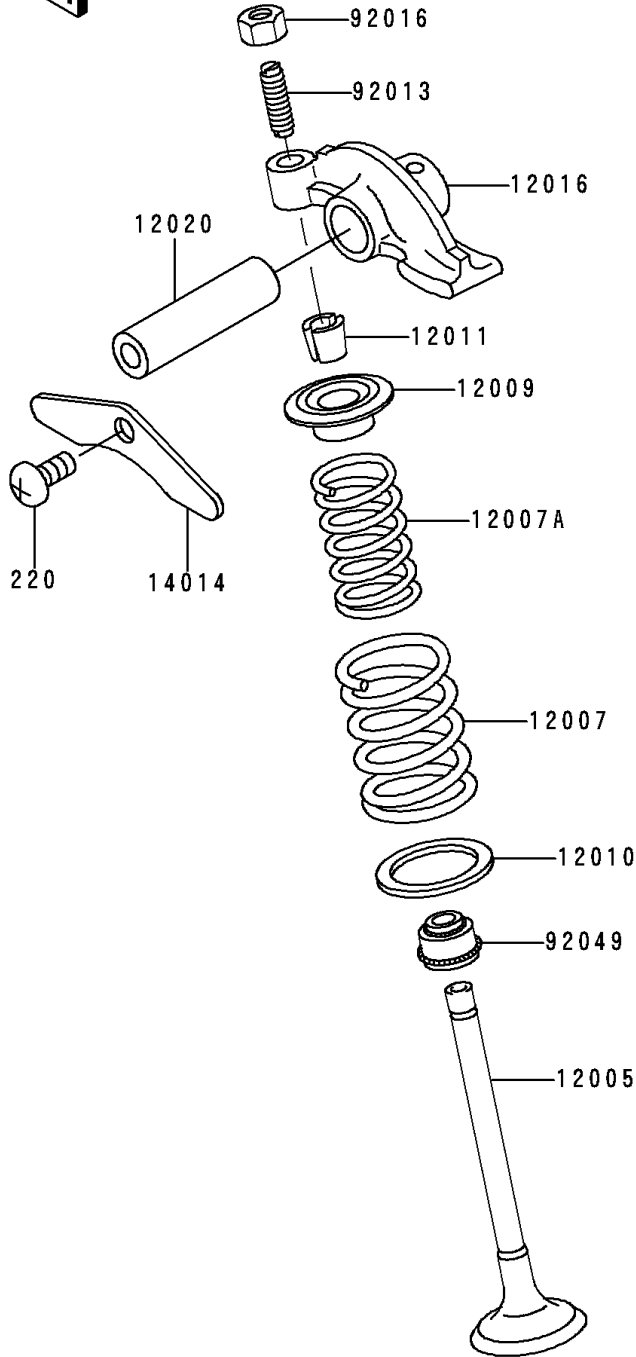

1997 Lakota 300 PARTS LIST

Valve(s)

ITEM NAME	PART NUMBER	QUANTITY
SCREW-PAN-CROS,6X10 (Ref # 220)	220B0610	1
VALVE-INTAKE (Ref # 12004)	12004-1123	1
VALVE-EXHAUST (Ref # 12005)	12005-1005	1
SPRING-ENGINE VALVE,OUTER (Ref # 12007)	12007-013	2
SPRING-ENGINE VALVE,INNER (Ref # 12007A)	12007-014	2
RETAINER-VALVE SPRING (Ref # 12009)	12009-006	2
SEAT-SPRING,OUTER (Ref # 12010)	12010-005	2
COLLET,RETAINER (Ref # 12011)	12011-004	4
ARM-ROCKER (Ref # 12016)	12016-1078	2
SHAFT-ROCKER (Ref # 12020)	12020-004	2
PLATE-POSITION (Ref # 14014)	14014-034	1
SCREW,6MM (Ref # 92013)	92013-009	2
NUT,6MM (Ref # 92016)	92016-061	2
SEAL-OIL,RV37129.5 (Ref # 92049)	92049-016	2