

# 1997 Lakota 300 PARTS DIAGRAM

Generator

E1810

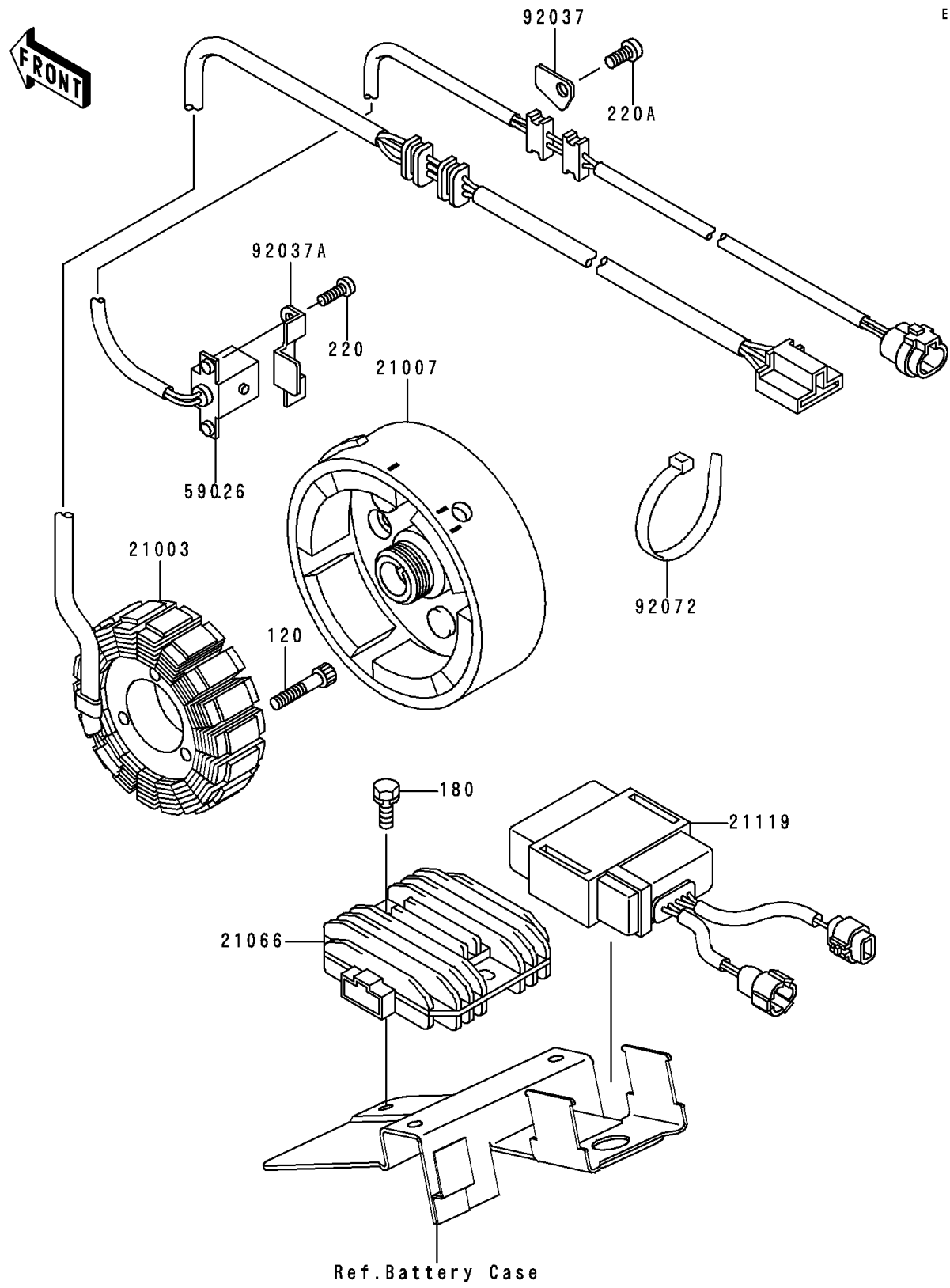

# 1997 Lakota 300 PARTS LIST

## Generator

ITEM NAME	PART NUMBER	QUANTITY
BOLT-SOCKET,6X30 (Ref # 120)	120P0630	3
BOLT-UPSET-WS (Ref # 180)	180B0630	2
SCREW-PAN-CROS (Ref # 220)	220B0514	2
SCREW-PAN-CROS,6X12 (Ref # 220A)	220B0612	1
STATOR (Ref # 21003)	21003-1276	1
ROTOR (Ref # 21007)	21007-1179	1
REGULATOR-VOLTAGE (Ref # 21066)	21066-1089	1
IGNITER (Ref # 21119)	21119-1369	1
COIL-PULSING (Ref # 59026)	59026-1092	1
CLAMP,WIRING HARNESS (Ref # 92037)	92037-1656	1
CLAMP (Ref # 92037A)	92037-1987	1
BAND,L=188 (Ref # 92072)	92072-1239	1