

1997 Lakota 300 PARTS DIAGRAM

Starter Motor

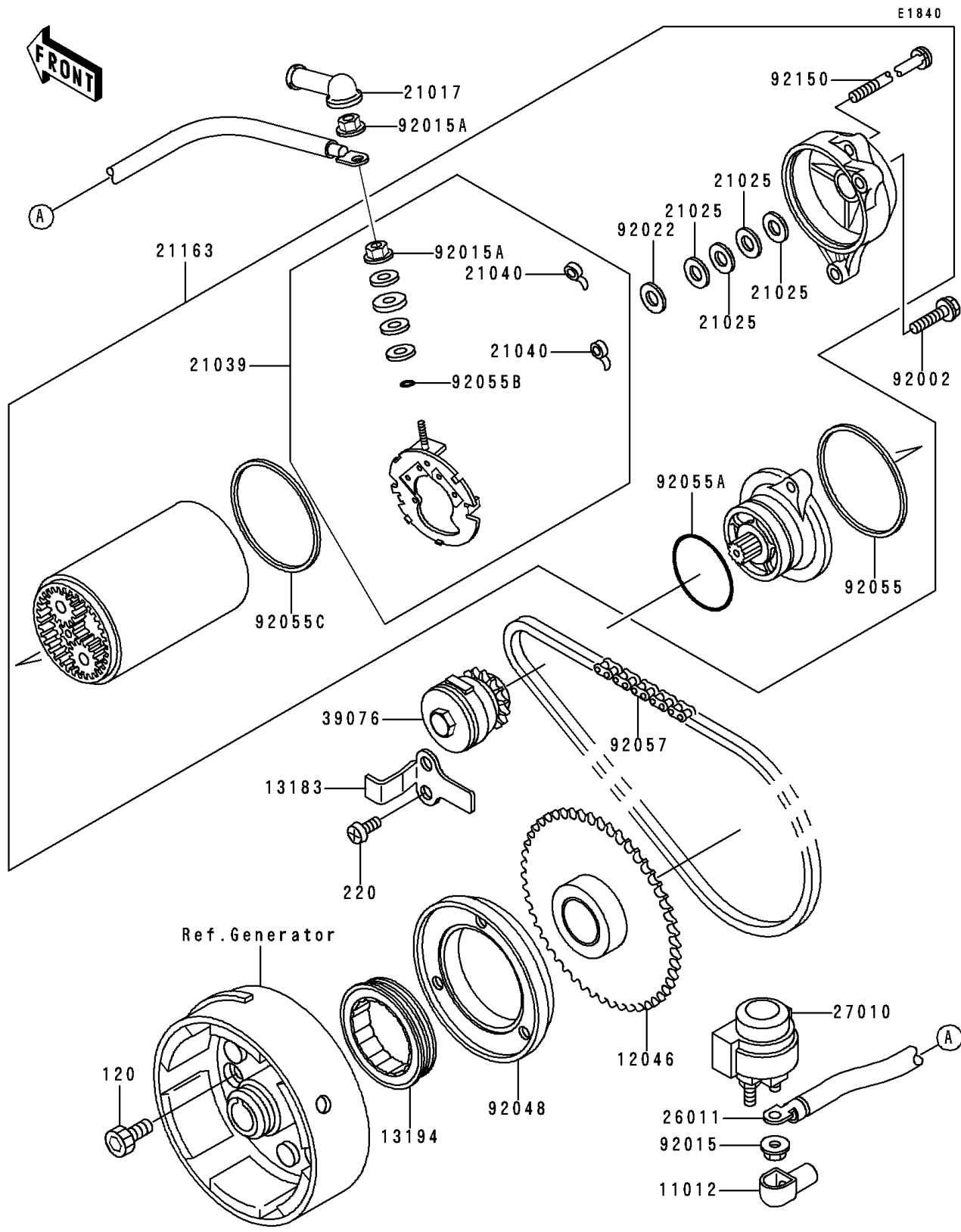

1997 Lakota 300 PARTS LIST

Starter Motor

ITEM NAME	PART NUMBER	QUANTITY
BOLT-SOCKET (Ref # 120)	120P0816	3
SCREW-PAN-CROS,6X12 (Ref # 220)	220B0612	1
CAP,TERMINAL (Ref # 11012)	11012-1354	1
SPROCKET,STARTER (Ref # 12046)	12046-1077	1
PLATE,STARTER CHAIN (Ref # 13183)	13183-1002	1
CLUTCH-ONEWAY (Ref # 13194)	13194-1091	1
GROMMET,STARTER TERMINAL (Ref # 21017)	21017-017	1
WASHER,9.1X18X0.2 (Ref # 21025)	21025-011	4
BRUSH,CARBON (Ref # 21039)	21039-1063	1
SPRING-BRUSH (Ref # 21040)	21040-1057	2
STARTER-ELECTRIC (Ref # 21163)	21163-1141	1
WIRE-LEAD,STARTER MOTOR (Ref # 26011)	26011-1634	1
SWITCH (Ref # 27010)	27010-1351	1
LIMITER,STARTER IDLE GEAR (Ref # 39076)	39076-1054	1
BOLT (Ref # 92002)	92002-1664	2
NUT,FLANGED,6MM (Ref # 92015)	92015-1367	2
NUT,STARTER MOTOR (Ref # 92015A)	92015-1476	2
WASHER,9.1X18X0.8 (Ref # 92022)	92022-1132	1
RACE,ONEWAY CLUTCH (Ref # 92048)	92048-1095	1
RING-O,64MM (Ref # 92055)	92055-1086	1
RING-O,42.8MM (Ref # 92055A)	92055-1313	1
RING-O,4.5X2.0 (Ref # 92055B)	92055-1370	1
RING-O,STARTER MOTOR (Ref # 92055C)	92055-1381	1
CHAIN,STARTER,KEC29H,64L (Ref # 92057)	92057-1196	1
BOLT,STARTER MOTOR (Ref # 92150)	92150-1138	2