

1999 Lakota 300 PARTS DIAGRAM

Swingarm

F2141

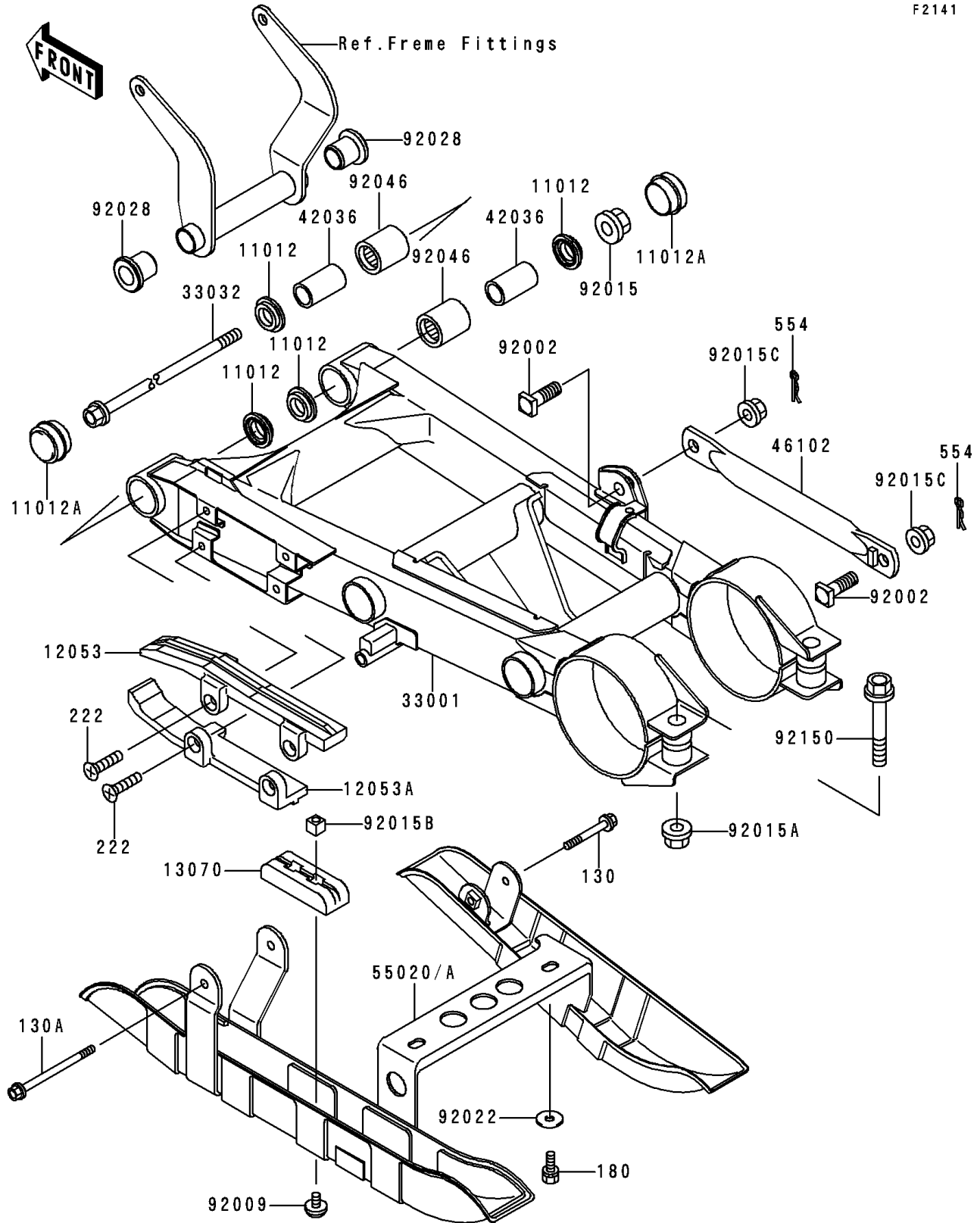

1999 Lakota 300 PARTS LIST

Swingarm

ITEM NAME	PART NUMBER	QUANTITY
BOLT-FLANGED,6X40 (Ref # 130)	130G0640	1
BOLT-FLANGED (Ref # 130A)	130G0680	1
BOLT-UPSET-WS,6X14 (Ref # 180)	180G0614	2
SCREW-CSK-RD-CROS,6X12 (Ref # 222)	222B0612	4
PIN-SNAP,10MM (Ref # 554)	554A1000	2
CAP,SWING ARM (Ref # 11012)	11012-1259	4
CAP,SWING ARM (Ref # 11012A)	11012-1520	2
GUIDE-CHAIN,UPP (Ref # 12053)	12053-1194	1
GUIDE-CHAIN,LWR (Ref # 12053A)	12053-1195	1
GUIDE,CHAIN (Ref # 13070)	13070-1156	1
ARM-COMP-SWING,SILVER NO.40 (Ref # 33001)	33001-1462-5A	1
SHAFT-SWING ARM (Ref # 33032)	33032-1139	1
SLEEVE,SWING ARM (Ref # 42036)	42036-1064	2
ROD,TORQUE,SILVER NO.40 (Ref # 46102)	46102-1342-5A	1
GUARD,CHAIN&DICS,SILVER (Ref # 55020A)	55020-1583-5A	1
BOLT,10X28 (Ref # 92002)	92002-1733	2
SCREW,6X10,WHITE (Ref # 92009)	92009-1286	2
NUT,14MM (Ref # 92015)	92015-1407	1
NUT,12MM (Ref # 92015A)	92015-1426	2
NUT,6MM (Ref # 92015B)	92015-1452	2
NUT,LOCK,10MM (Ref # 92015C)	92015-1597	2
WASHER,6.5X20X1.6 (Ref # 92022)	92022-1804	2
BUSHING,SWING ARM (Ref # 92028)	92028-1261	2
BEARING-NEEDLE,TA2030Z (Ref # 92046)	92046-1128	2
BOLT,FLANGED,12X62 (Ref # 92150)	92150-1842	2