

1997 Lakota 300 PARTS DIAGRAM

Footrests

F2160

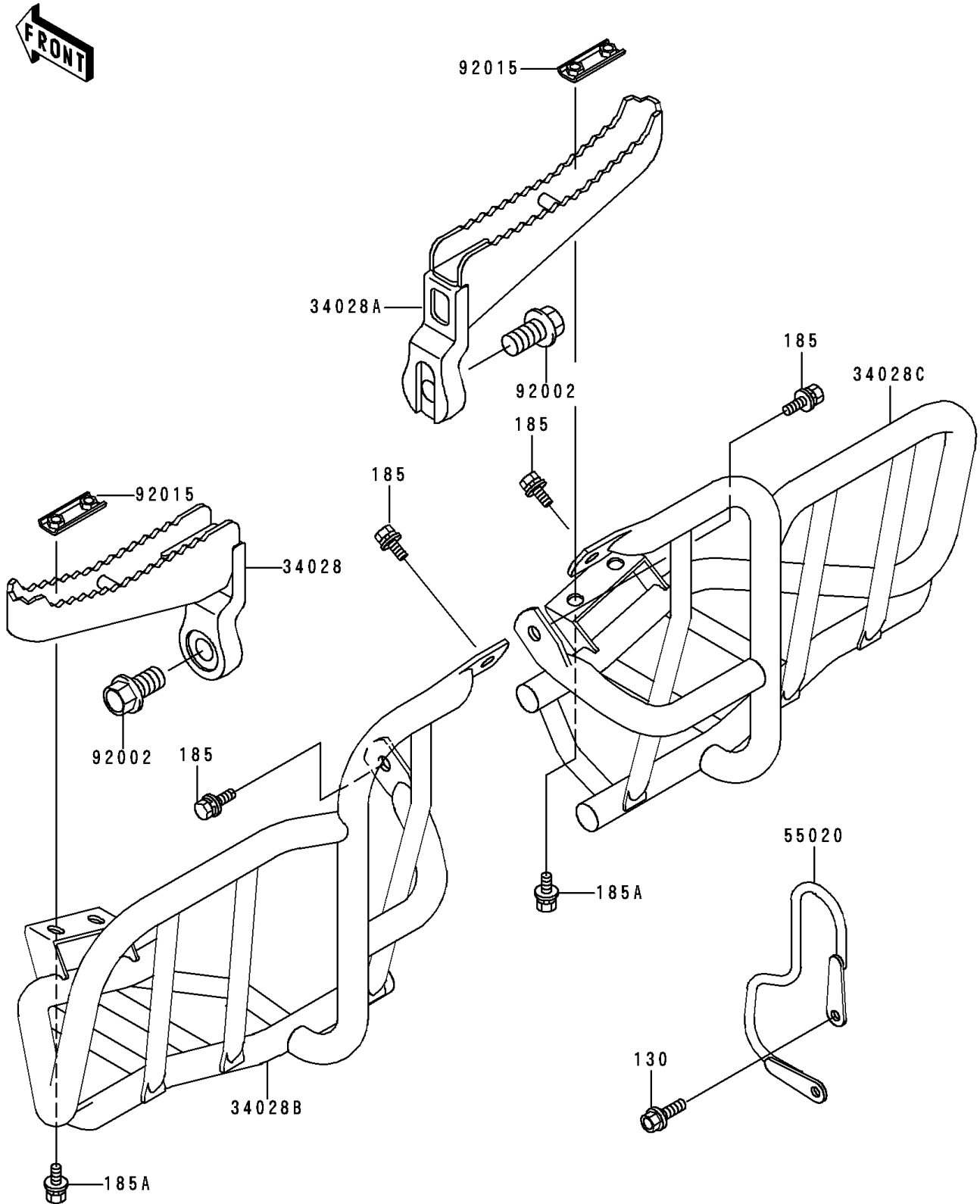

1997 Lakota 300 PARTS LIST

Footrests

ITEM NAME	PART NUMBER	QUANTITY
BOLT-FLANGED,6X12 (Ref # 130)	130G0612	2
BOLT-UPSET-WSP-SMALL (Ref # 185)	185J0818	4
BOLT-UPSET-WSP-SMALL,8X20 (Ref # 185A)	185J0820	4
STEP,LH,SILVER NO.40 (Ref # 34028)	34028-1391-5A	1
STEP,RH,SILVER NO.40 (Ref # 34028A)	34028-1392-5A	1
STEP,FOOT BOARD,LH,SILVER (Ref # 34028B)	34028-1397-5A	1
STEP,FOOT BOARD,RH,SILVER (Ref # 34028C)	34028-1398-5A	1
GUARD,CHAIN,LEFT SIDE,SILVER (Ref # 55020)	55020-1526-5A	1
BOLT,FLANGED,14X25 (Ref # 92002)	92002-1767	2
NUT (Ref # 92015)	92015-1732	2