

# 1995 Lakota 300 PARTS DIAGRAM

Front Brake

F2292

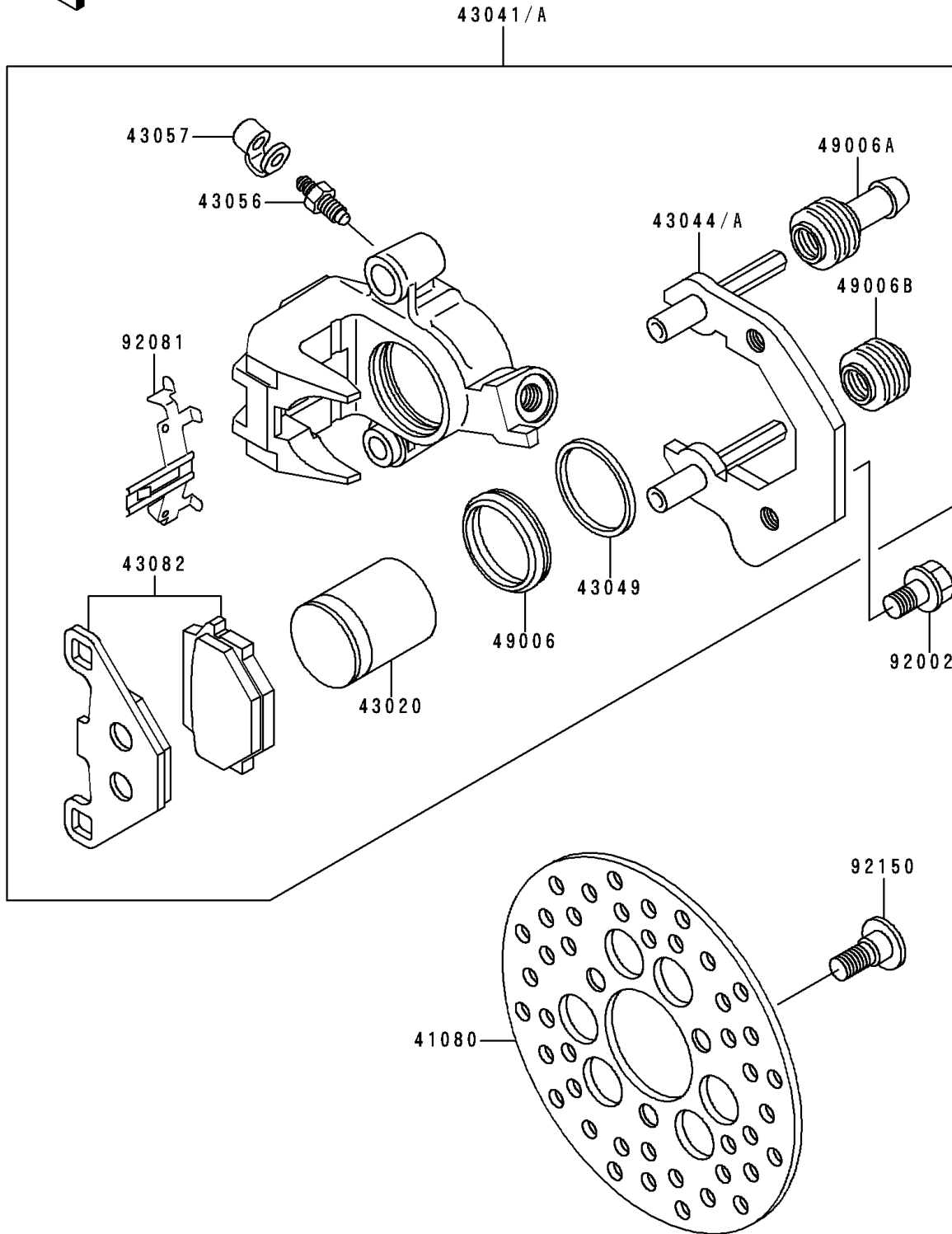

# 1995 Lakota 300 PARTS LIST

## Front Brake

ITEM NAME	PART NUMBER	QUANTITY
DISC,FR (Ref # 41080)	41080-1171	2
PISTON-COMP-BRAKE (Ref # 43020)	43020-1093	2
CALIPER-ASSY,FR,LH (Ref # 43041)	43041-1522	1
CALIPER-ASSY,FR,RH (Ref # 43041A)	43041-1523	1
HOLDER-COMP-CALIPER,FR,LH (Ref # 43044)	43044-1064	1
HOLDER-COMP-CALIPER,FR,RH (Ref # 43044A)	43044-1065	1
PACKING (Ref # 43049)	43049-1016	2
BREATHER-BRAKE (Ref # 43056)	43056-1054	2
CAP-BREATHER (Ref # 43057)	43057-003	2
PAD-ASSY-BRAKE (Ref # 43082)	43082-1067	2
BOOT,PISTON SEAL (Ref # 49006)	49006-1053	2
BOOT,CALIPER (Ref # 49006A)	49006-1054	2
BOOT,CALIPER (Ref # 49006B)	49006-1055	2
BOLT,FLANGED,8X13 (Ref # 92002)	92002-1737	4
SPRING,PAD (Ref # 92081)	92081-1341	2
BOLT,SOCKET,8X20 (Ref # 92150)	92150-1760	6