

1996 Lakota 300 PARTS DIAGRAM

Fuel Tank

F2410

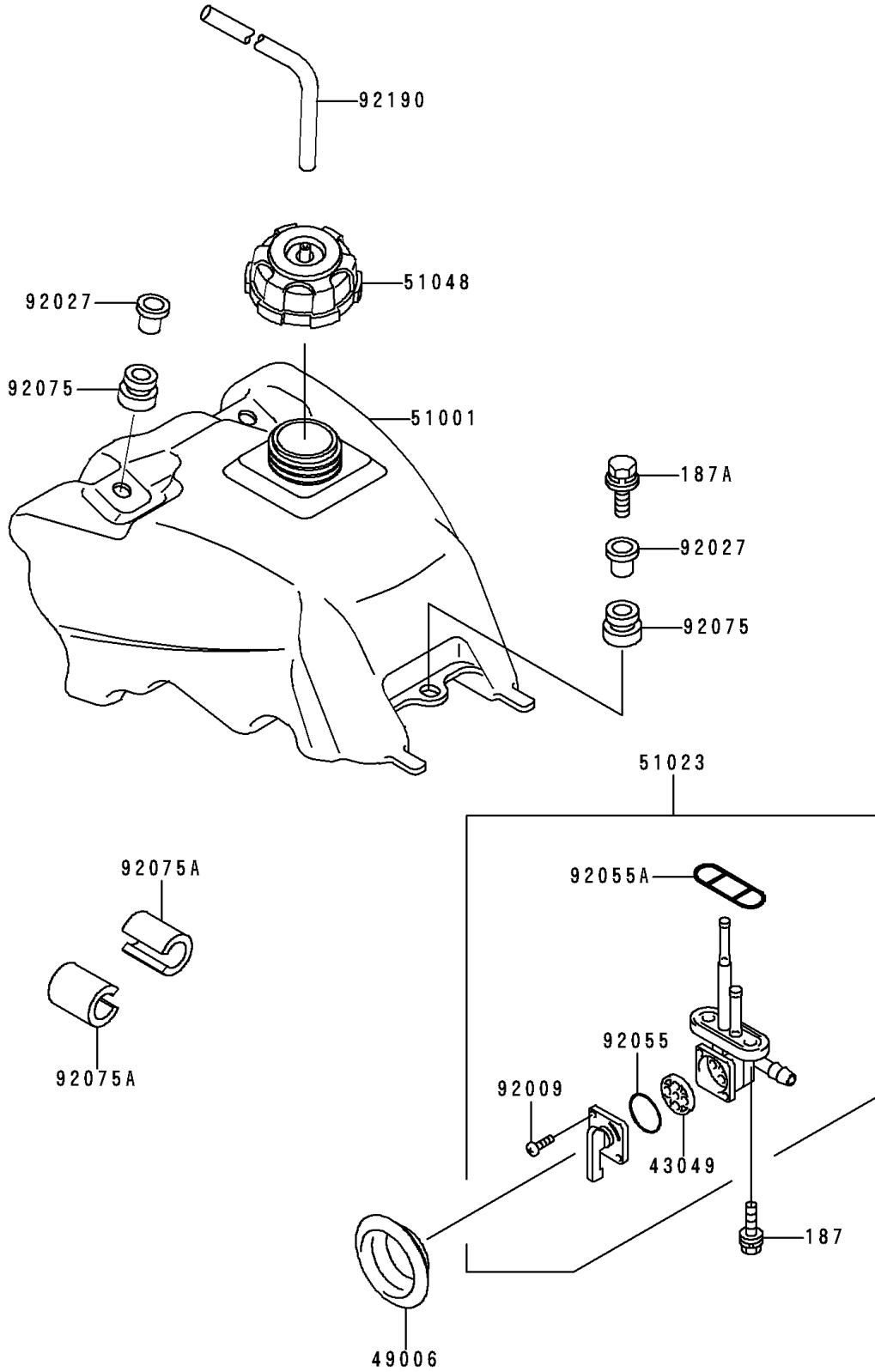

1996 Lakota 300 PARTS LIST

Fuel Tank

ITEM NAME	PART NUMBER	QUANTITY
-----------	-------------	----------