

1998 Lakota 300 PARTS DIAGRAM

Guard(s)

F2680

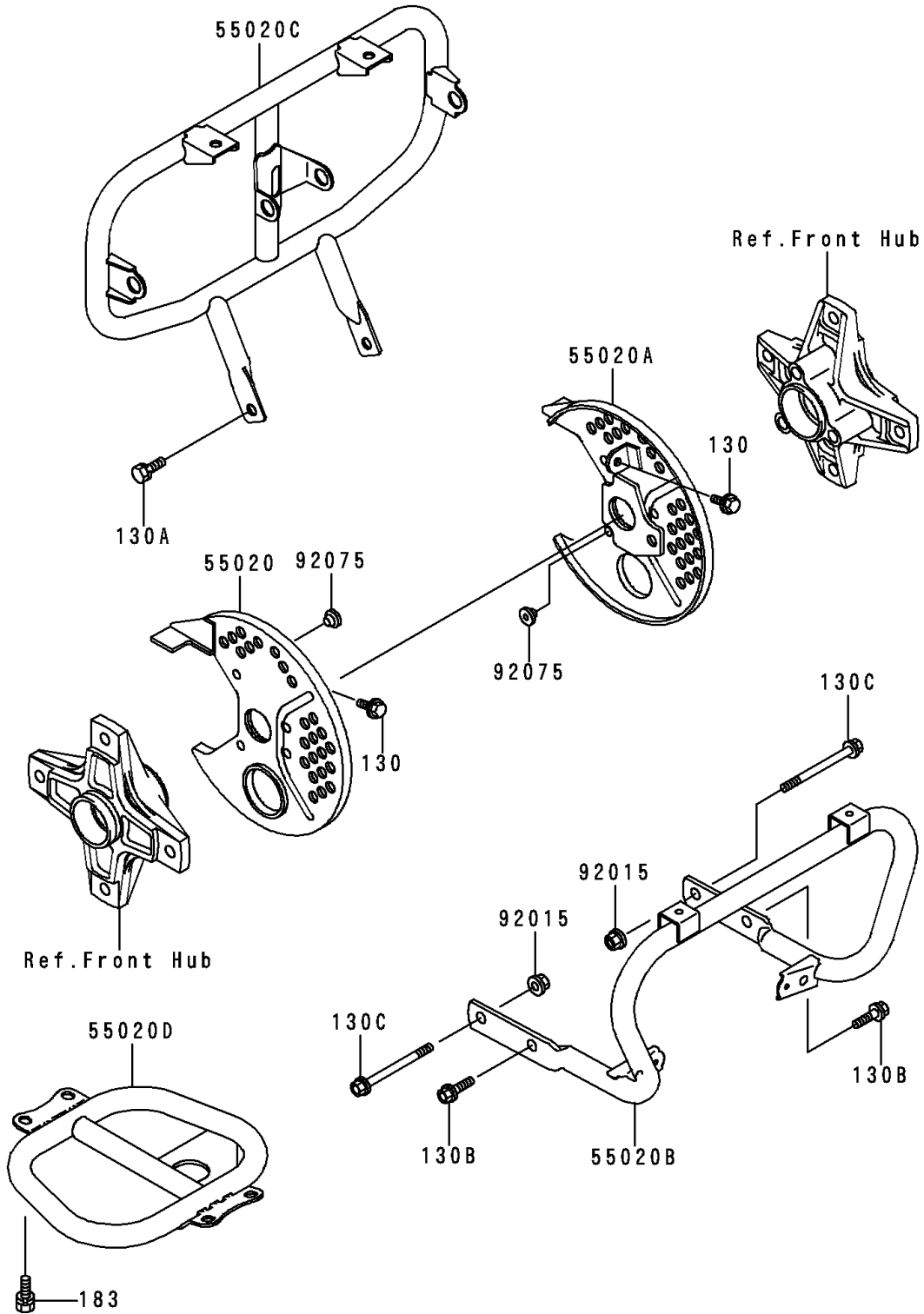

1998 Lakota 300 PARTS LIST

Guard(s)

ITEM NAME	PART NUMBER	QUANTITY
BOLT-FLANGED,6X10 (Ref # 130)	130B0610	2
BOLT-FLANGED,8X16 (Ref # 130A)	130G0816	2
BOLT-FLANGED,8X20 (Ref # 130B)	130G0820	2
BOLT-FLANGED (Ref # 130C)	130Z0865	2
BOLT-UPSET-WS-SMALL (Ref # 183)	183J0814	4
GUARD,FRONT HUB,INNER,LH (Ref # 55020)	55020-1223	1
GUARD,FRONT HUB,INNER,RH (Ref # 55020A)	55020-1224	1
GUARD,RR,SILVER NO.40 (Ref # 55020B)	55020-1515-5A	1
GUARD,FRONT HEAD,SILVER NO.40 (Ref # 55020C)	55020-1516-5A	1
GUARD,ENGINE,SILVER NO.40 (Ref # 55020D)	55020-1517-5A	1
NUT,8MM (Ref # 92015)	92015-1432	2
DAMPER,INNER (Ref # 92075)	92075-1822	6