

1995 Lakota 300 PARTS DIAGRAM

Ignition Switch

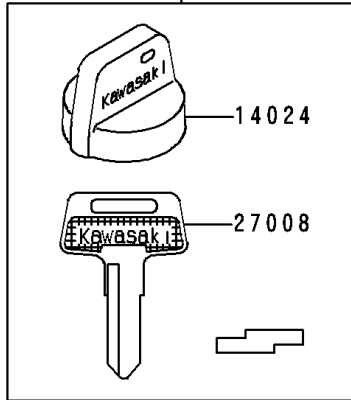

27008D



27008E

F2770

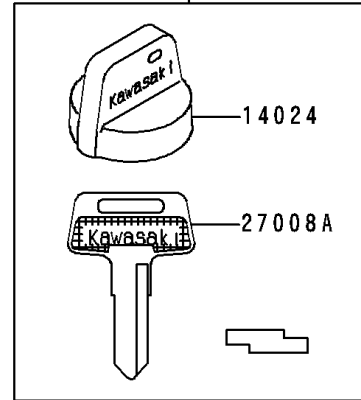

27008F

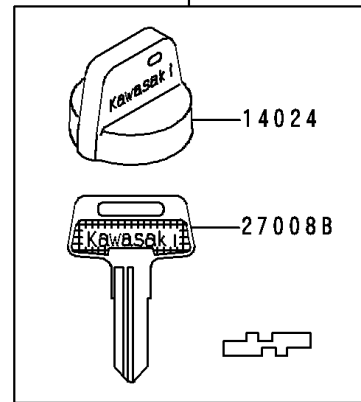

27008G

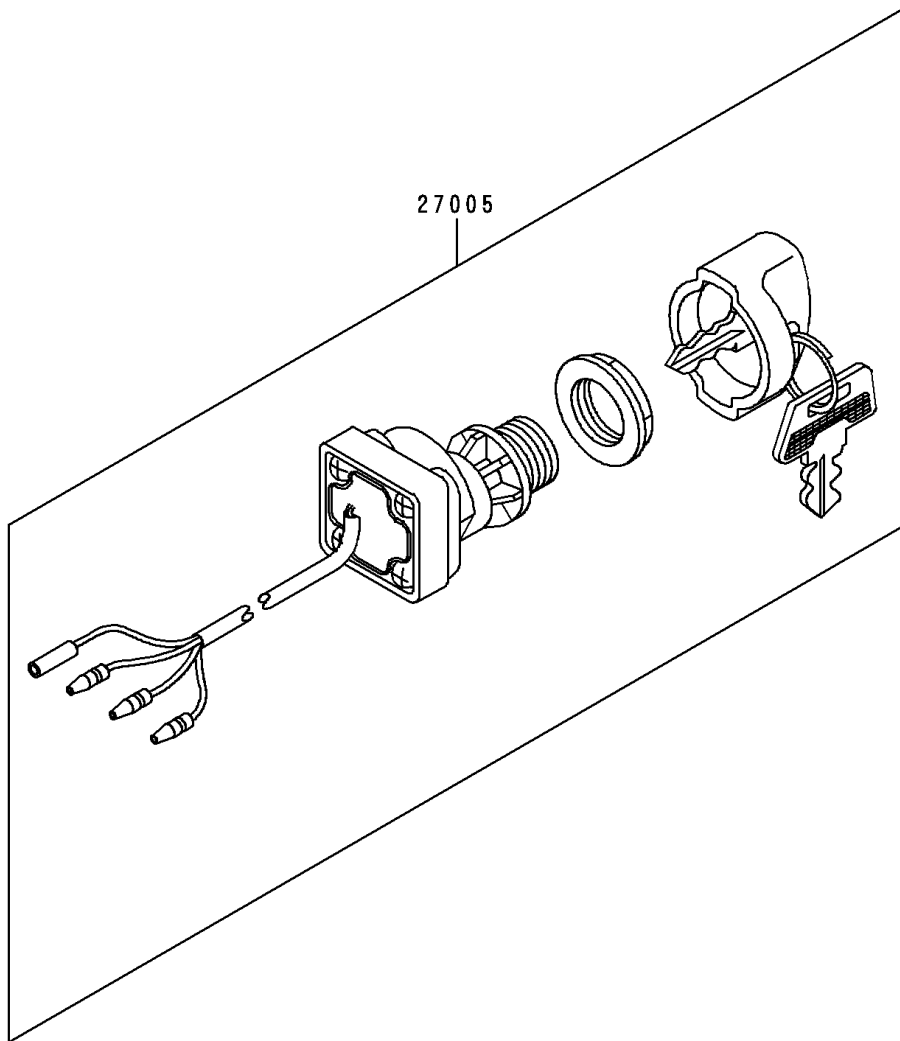
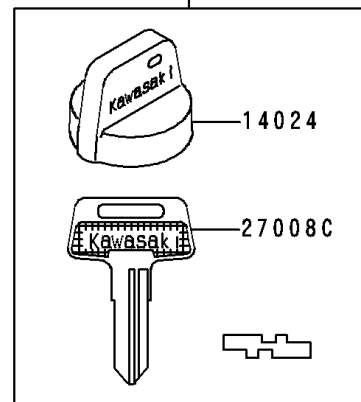

1995 Lakota 300 PARTS LIST

Ignition Switch

ITEM NAME	PART NUMBER	QUANTITY
COVER,KEY (Ref # 14024)	14024-1551	4
SWITCH-ASSY-IGNITION (Ref # 27005)	27005-1186	1
KEY-LOCK,BLANK (Ref # 27008)	27008-1041	1
KEY-LOCK,BLANK (Ref # 27008A)	27008-1042	1
KEY-LOCK,BLANK (Ref # 27008B)	27008-1043	1
KEY-LOCK,BLANK (Ref # 27008C)	27008-1044	1
KEY-LOCK,BLANK (Ref # 27008D)	27008-1132	1
KEY-LOCK,BLANK (Ref # 27008E)	27008-1133	1
KEY-LOCK,BLANK (Ref # 27008F)	27008-1134	1
KEY-LOCK,BLANK (Ref # 27008G)	27008-1135	1